



TG uni 1

TG uni 1 A

TG euro 1

TG euro 1 A

TG euro 1 med

TG euro 1 A med

Appliance tester for testing
protective measures in accordance
with DIN VDE 0701-0702 / EN 62638
and DIN VDE 0751-1 / EN 62353

Operating manual
Version 5.0.28 or higher



Operating manual for the TG uni 1, TG euro 1 and TG euro 1 med appliance tester

Contents

Content	Page	Content	Page
1. Safety information	4	8.3.5 Leakage current from the applied part – Alternative measurement	15
2. Introduction	4	8.3.6 Patient leakage current (I_{PA})	15
2.1 Model and type designation / identification	5	8.3.7 Leakage current from the applied part	15
2.2 Product description	5	8.3.8 Patient leakage current – Mains voltage at the applied part	15
2.3 Other equipment features	5	8.3.9 Leakage current from applied part – Mains voltage at applied part	15
2.4 Scope of delivery	5	8.4 Insulation resistance (R_{ISO})	15
2.5 Optional accessories	5	8.5 Protective measures	15
2.6 Transport and storage	5	8.5.1 Devices with a protective earth connector (PC I)	15
3. Safety instructions	6	8.5.2 Devices without a protective earth connector (PC II)	15
4. Appropriate usage	7	8.5.3 Devices connected to PELV electric circuits (PC III)	15
5. Operating elements	8	8.6 Protective conductor current (I_{PE})	16
5.1 Meaning of the signal tones	8	8.7 Protective conductor resistance (R_{PE})	16
6. Starting up	9	8.8 Visual inspection	16
6.1 Basic settings of the appliance tester	9	9. Conducting tests in accordance with DIN VDE 0701-0702:	
6.2 Compensation of the measuring line	10	Definition of standards	17
6.3 Setting the measuring method for protective cond. current measurement	10	9.1 Visual inspection	17
6.4 Setting the date	11	9.2 Measuring the protective conductor resistance	17
6.5 Customer-specific settings	11	9.3 Measuring insulation resistance	17
6.6 Changing the duration of a test stage	11	9.4.1 Measuring the protective conductor current	18
6.7 Entering the name of the inspector	11	9.4.2 Measuring touch current	19
6.8 Activating the control code	12	9.5 Inspecting the inscriptions	19
6.9 Expert mode	12	9.6 Function test	19
6.10 Selecting the menu language	12	9.7 Documentation	19
6.11 Selecting of the data memory	12	9.8 Diagram 1: Test procedure for devices with prot. conductor (PC I)	20
7. Conducting tests: General information on DIN VDE 0701-0702	13	9.9 Diagram 2: Test procedure for devices without prot. conductor (PC II)	21
8. Conducting tests: Explanation of terminology	14	10. Conducting tests with the appliance tester: According to DIN VDE 0701-0702, Example 1 - devices with protective conductor (PC I)	22
8.1 Touch current (I_b)	14	Visual inspection	25
8.2 Differential current (I_D)	14	Protective conductor resistance	26
8.3 Device leakage current (I_{GA})	14	Insulation resistance	26
8.3.1 Substitute leakage current (I_{EA})	14	10.4.1 Protective conductor current (substitute leakage current)	27
8.3.2 Substitute device leakage current (I_{EGA})	14	10.4.2 Protective conductor current	27
8.3.3 Device leakage current – Alternative measurement (I_{GA})	14	10.5 Function test	28
8.3.4 Substitute patient leakage current (I_{EPA})	15	10.6 Inspecting the inscriptions	28
		10.7 Documentation	29

Content	Page	Content	Page
11. Conducting tests with the appliance tester: According to DIN VDE 0701-0702, Example 2 - devices without protective conductor (PC II)	31	16. Conducting tests with the appliance tester: According to DIN VDE 0751-1, Example 4 - Devices with protective conductor (PC I) and applied part type B (at TG euro 1 med only)	55
11.1 Visual inspection	33	16.1 Visual inspection	58
11.2 Insulation resistance	34	16.2 Protective conductor resistance	58
11.3.1 Touch current (substitute leakage current)	34	16.3 Insulation resistance (optional)	59
11.3.2 Touch current	35	16.4 Leakage currents	59
11.4 Function test	36	16.5 Function test	60
11.5 Inspecting the inscriptions	36	16.6 Inspecting the inscriptions	60
11.6 Documentation	36	16.7 Documentation	60
12. Conducting tests with the appliance tester: According to DIN VDE 0701-0702, Example 3 - devices with SELV/PELV (PC III)	38	17. Conducting tests with the appliance tester: According to DIN VDE 0751-1, Example 5 - Devices without protective conductor (PC II) and with applied part type CF (at TG euro 1 med only)	61
12.1 Visual inspection	41	17.1 Visual inspection	64
12.2 Insulation resistance	41	17.2 Leakage currents	64
12.3 Documentation	42	17.3 Leakage current from the applied part	65
13. Conducting tests with the appliance tester: Examples of control codes (at TG euro 1 / TG euro 1 med only)	43	17.4 Function test	65
14. Conducting tests with the appliance tester: According to DIN VDE 0701-0702, Special test procedure according to customer-specific settings	44	17.5 Inspecting the inscriptions	65
15. Conducting tests in accordance with DIN VDE 0751-1: Definition of standards (for TG euro 1 med only)	46	17.6 Documentation	66
15.1 General information	46	18. Conducting tests with the appliance tester: According to DIN VDE 0751-1, Example 6 - Testing removable cables (at TG euro 1 med only)	66
15.2 Sequence of tests	46	18.1 Visual inspection	68
15.3 Inspection (visual inspection)	47	18.2 Protective conductor resistance	68
15.4 Protective conductor resistance	47	18.3 Insulation resistance	69
15.5 Leakage currents	48	18.4 Documentation	69
15.6 Insulation resistance	52	19. Technical data	70
15.7 Function test	52	19.1 Technical data for function tests	71
15.8 Assessment	52	19.2 General technical data	71
15.9 Documentation	52	19.3 Calibrating the appliance tester	71
15.10 Diagram 1: Test procedure for ME devices with protection class I	53	20. Note on using the internal memory or external memory (MMC/SD card) of the appliance tester	72
15.11 Diagram 2: Test procedure for ME devices with protection class II	54	21. Manufacturer's guarantee conditions	72

1. Safety information

Tests on the electrical safety of electrical appliances may only be carried out by qualified electricians or under their supervision. Carefully read through the following safety information before starting up the appliance tester.

Symbols used in the operating manual and on the appliance tester:



Warning: hazardous situation. Follow the operating manual.



Caution! Dangerous voltage, danger of electric shock.



Note. Make sure you follow the manual.



CE mark of conformity.



The operating manual contains information and notes which are necessary for the safe operation and use of the appliance tester. Before using (starting up/installing) the appliance tester, the operating manual should be carefully read through and followed in all points.



If the manual is not observed or if you fail to observe the warnings and notes, serious injury to the user and damage to the appliance tester can occur.



All the technical data and quoted standards in this manual are up-to-date at the time of going to press and have been determined to the best of our knowledge, nevertheless this data may be subject to errors and printing errors. Therefore no legal responsibility or any other liability can be accepted for incorrect information or the consequences of this information. **The respective provisions, regulations and standards are the authorities defining the procedures to be followed when conducting tests.** There is no intention to infringe on any existing patents and other property rights with this publication.

2. Introduction

You have acquired a high-grade device from the company Gilgen, Mueller & Weigert Nuremberg (GMW) with which you can carry out repeatable measurements over a very long period of time. The product was calibrated during the manufacturing process in accordance with the specified operating procedures.

2.1 Model and type designation / identification

A type plate and series number sticker are situated on the inside of the housing cover (behind the accessories bag).

In the case of queries, always give the product designation and series number.

2.2 Product description

The appliance tester has been developed for carrying out the following measurements for testing the safety of electrical appliances in accordance with DIN VDE 0701-0702/EN 62638 (BGV A3) and DIN VDE 0751-1/EN 62353:

- Measuring protective conductor resistance with compensation of the measuring line
- Measuring insulation resistance
- Measuring substitute leakage current
- Measuring protective conductor current - direct method or as differential current
- Measuring touch current - direct method or as differential current
- Measuring device leakage current / leakage current from the applied part - alternative measurement *(at TG euro 1 med only)*
- Measuring device leakage current - direct method or as differential current *(at TG euro 1 med only)*
- Measuring the leakage current from the applied part - mains voltage at the applied part *(at TG euro 1 med only)*
- Function test with measurement of mains voltage, load current, active power, apparent power and reactive power, power factor and frequency
- Testing of non-heating devices and extension cables

2.3 Other equipment features

- Stable, dust-proof carrying case as housing
- Large, easy-to-read touch-screen for operating the tester (backlit)
- Good/bad display in plain text (suitable for technically trained persons)
- Connection for barcode scanner for reading-in the test object's ID numbers
- USB interface
- MMC/SD card for storing and transferring measurement data

2.4 Scope of delivery (order no. in brackets)

- 1 Appliance tester
- 1 measurement accessory set (7910086048) with safety test line, safety crocodile clip and safety test tip
- 1 USB cable (7910086047)
- 1 MMC 128 MB or SD 1 GB memory card (7910086046)
- 1 CD-ROM with Windows® standard PC software (7910086050)
- 1 accessories bag with Velcro fastener (3214086006)
- 1 quick guide (3531086006)
- 1 operating manual, printed DIN A5 book (2786688240)

2.5 Optional accessories (not included in delivery)

- Barcode scanner (7910086044)
- TGA three-phase adapter (7920018691) for testing devices with three-phase connection - active for 5-pole 32 A 400 V CEE plugs
- TGP three-phase adapter (7920018690) for testing devices with three-phase connection - active for 3-pole 16 A 230 V CEE plugs; passive for 5-pole 16 A 400 V and 5-pole 32 A 400 V CEE plugs
- Adapter for checking extension cables (7920018680)
- Adapter for non-heating appliance plugs (7920018660)
- TG brush probe (7910086049) for touchable conductive rotating parts
- 12-unit adapter (6100001001) for contacting multiple applied parts *(for TG euro 1 med only)*

2.6 Transport and storage

Please retain the original packaging for dispatch at a later date, e.g. for calibration.

Transport damage that occurs due to inadequate packaging is not covered by the manufacturer's guarantee.

The appliance tester must be stored in a dry, closed room. If the device is transported in extreme temperatures, it requires at least 2 hours acclimatisation before being switched on.

Operating manual for the TG uni 1, TG euro 1 and TG euro 1 med appliance tester

Safety instructions

3. Safety instructions

The appliance tester was constructed and tested in accordance with the applicable safety regulations and left the workshop in a faultless safety condition. In order to maintain this condition and ensure safe operation, the user must observe the instructions and warnings contained in this operating manual.

 With all work, the applicable accident prevention regulations of the trade associations for electrical systems and equipment must be observed.

 To avoid electric shock, the applicable safety regulations and DIN-VDE regulations regarding high touch voltage must be observed without fail when working with voltages greater than 120 V DC or 50 V eff AC.

Measuring at a dangerous proximity to electrical systems should only be carried out under the instruction of a responsible electrician, and never alone.

Check the appliance tester and the connecting cables for external damage before every new operation.

Make sure that the appliance tester and the cable connections are in faultless condition. The appliance tester may not be used if one or more functions fail or if functional readiness is not evident.



The measuring lines and the measuring accessories may only be touched in the designated handling areas. Touching measuring connections, e.g. test tips, must be avoided under all circumstances.



If the safety of the operator is no longer guaranteed, the appliance tester must be decommissioned and secured against unwanted use. This is the case if the device:

- shows obvious signs of damage
- no longer carries out the required measurements
- has been stored under adverse conditions for too long

The appliance tester may only be used in the operating and measuring ranges specified under Technical data.

Avoid subjecting the appliance tester to heating from direct sunshine. Only this will guarantee faultless functioning and a long service life of the device.

Never open the housing of the appliance tester because of the danger of high voltages. The appliance tester contains no parts that can be replaced by the user.

4. Appropriate usage

The tester may only be used under the conditions and for the purposes for which it has been designed. It is particularly important to observe the safety instructions and the technical data regarding ambient conditions and usage in a dry environment.

The appliance tester may not be used for measuring in electrical systems. The appliance tester may only be plugged into a properly connected earthed mains socket. This may be protected with a maximum 16 A!

The appliance tester is designed for operation with a rated voltage of 230 V AC 50 Hz, it may never be connected to higher voltage.

The maximum output current of the mains socket is 16 A!
The appliance tester may not be used for constant measuring.

Operational safety is no longer guaranteed in the case of modifications or conversions that have not been carried out by the manufacturer.

Maintenance or calibration work may only be carried out by the manufacturer.

Subject the appliance tester to an electromagnetic field can impair the function of the appliance tester.

In order to avoid damaging the appliance tester, the test socket and the measuring connections may not be connected to an external voltage source.

Only the supplied original measuring lines or equivalent safety measuring accessories may be used!

Operating manual for the TG uni 1, TG euro 1 and TG euro 1 med appliance tester

Operating elements

5. Operating elements

Explanation of the connections, operating elements and displays of the appliance tester.

Mains cable with mains plug for connecting the appliance tester to the mains power supply 230 V +10%, -15%, 50 Hz

Thermal fuse for the test object and tester F 16 A

Mains switch

RS232 socket for connecting a barcode scanner

Test line, test tip and test clip in the mains cable storage compartment

USB socket for connecting a PC

Card slot for an MMC/SD memory card

Front panel, Fig. 1

Test/Mains socket for connecting test objects having an earthed plug, 230 V 16 A, 50 Hz

„IPEA“ connection socket (red) for the test line to the applied part (at TG euro 1 med only)

„Probe“ connection socket (red) for the test line

„PE“ connection socket (yellow), in parallel to the protective conductor contact in the test socket

Touch-screen (LC display and control screen)



Case housing, Fig. 2

Housing cover with 2 snap fasteners

Accessories bag with quick guide

Handle (fold-away)



5.1 Meaning of the signal tones

- Short single tone: confirmation of button press
- Short double tone: end of a test stage with automatic test procedure
- Long single tone, continuous tone: fault

6. Starting up

The appliance tester is equipped with modern touch-screen technology. This means that the LC display and the control buttons are in one control screen.

The control buttons are always edged.

After activating the mains switch a self-test is carried out.

If everything is in order, the following display appears on the touch-screen as a **switch-on message** (Fig. 3):

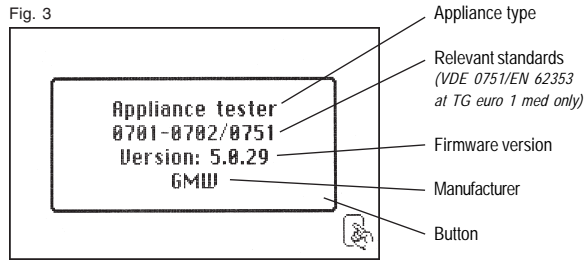

Continue with button (Fig. 3).

The „Device settings“ screen appears (Fig. 3a).

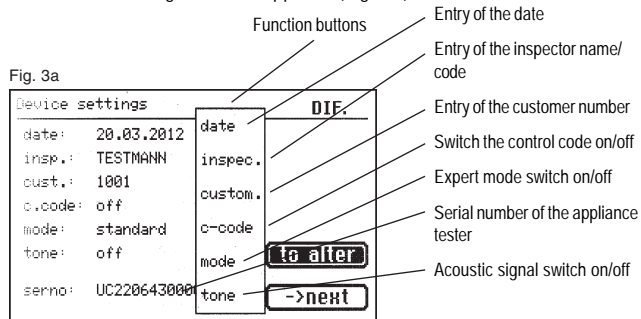

The necessary settings can be performed directly via the function buttons or the settings can be made via the configuration menu, see Point 6.1.

Since the appliance tester does not contain a real time clock, the test date shown here must either be confirmed or entered anew.

After confirmation with the [next] button the **Main menu** appears (Fig. 4):

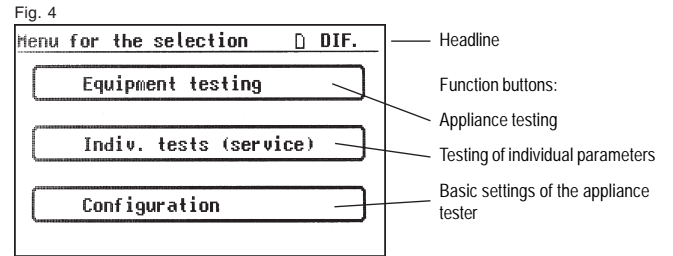

6.1 Basic settings of the appliance tester

Press the [Configuration] button in the Main menu (Fig. 4).

The **Configuration Menu** appears (Fig. 5):

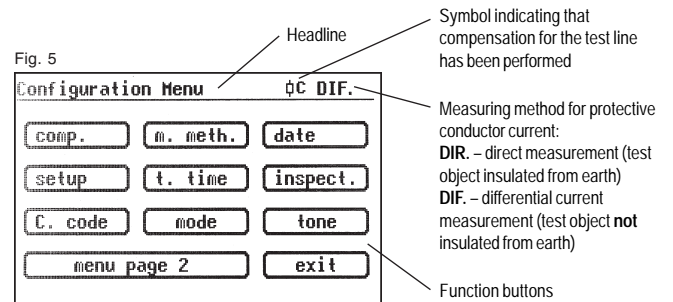

6.2 Compensation of the measuring line

In order to achieve correct results when measuring the protective conductor resistance, the resistance of the measuring line must be compensated (zero calibration). Press the **function button [comp.]** (Fig. 5). The Zero calibration menu appears. Follow the instructions in the display (Fig. 6):

Fig. 6

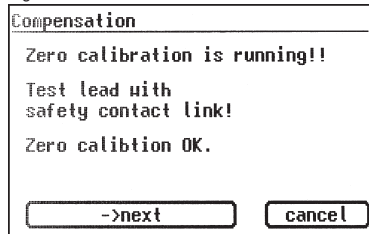

– Connect the test tip/test clip with the measuring line and insert the measuring line plug in the „Probe“ socket (Fig. 1).
– Connect the test tip/test clip with the protective earth contact of the test socket.

If the following message appears in the display: “Error: zero calibration”

and a permanent warning signal sounds, the measuring line resistance is greater than 2 Ω and cannot be compensated.

The protective conductor resistance test is locked.

In this case the measuring line should be checked or be replaced with a low-impedance version. If the measuring line has been successfully compensated – the following message appears in the display: „Zero calibration OK.“ Press the [next] button, only then disconnect the line! A symbol for successful compensation appears in the headline of the configuration menu (Fig. 5): 

6.3 Setting the measuring method – protective conductor current measurement

In the case of devices of protection class I, where the insulation resistance measurement cannot or may not be carried out, the protective conductor current measurement is to be performed either directly or with the differential current method. The protective conductor current can be determined either by the direct measuring method, the differential current method or the substitute leakage current method. The direct measuring method or the differential current method should be used with test objects that can only be

switched on with mains voltage (also see Point 9.8).



Caution! In this case the test object is supplied with mains voltage during the test.

The differential current measurement determines the total leakage current of the test object by measuring the total current of all active conductors (L-N). **The differential current measurement** must be applied if the test object has additional earth connections or cannot be insulated. **Direct measurement** can be used if the test object has no additional earth connections or is insulated.



WARNING! The test object must be insulated in order to correctly measure the protective conductor current.

To change the measuring method, press the [m. meth.] function button in the configuration menu, see Fig 5.

The symbol in the headline changes accordingly:

[DIR.] – direct measurement

[DIF.] – differential current method

6.4 Setting the date

You can set the test date on the appliance tester. Press the **function button [date]** to change to the input screen (Fig. 5). The date is entered on the touch-screen by means of the pictured 10-button keypad (Fig. 7). The following formats are possible: |D.M.YY|, |DD.MM.YY| and |DD.MM.YYYY|. The set date is saved along with the measuring results of every test and also appears in the log printout.

Fig. 7

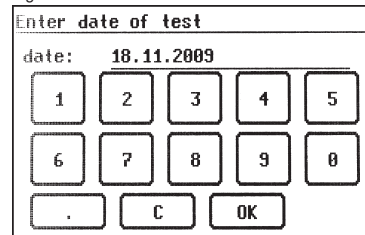

Once the date has been set it remains unchanged in the memory of the appliance tester until modified or deleted – the appliance tester does **not** have a real time clock!

6.5 Customer-specific settings

The scope of functions of the appliance tester can be adapted to customer specifications. This can simplify the operation of the appliance tester.

These settings do not change the standard conformity of the appliance tester! You reach the setup menu by pressing the **[setup] function button** in the configuration menu (Fig. 5) - see also point 14 function on page 44.

Fig. 10

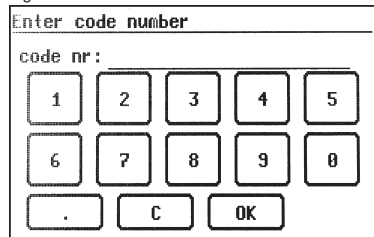

 This input area is locked by a code key (Fig. 10). Please contact us for further information: Email - info@g-mw.de

6.6 Changing the duration of a test stage (automatic mode)

The default duration of each test stage is set to 3 s at the factory. This setting can be changed if for example the test object requires a longer time to be switched on.

Press the **[t. time] function button** in the configuration menu. Using the 10-button keypad, you can enter a new test time in the next screen (Fig. 8). The possible setting range is 3 to 600 seconds.

Fig. 8

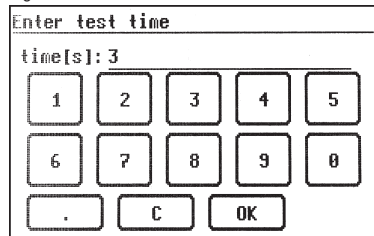

6.7 Entering the name of the inspector

To enter the name or designation of the inspector, press the **[inspect] function button** in the configuration menu. The screen changes to an alphanumeric keypad. The input field has 20 characters (Fig. 9). You can switch between alphabetic and numeric keys by using the buttons [123] or [ABC]. The entered name remains saved in the memory even after the tester has been switched off.

Fig. 9

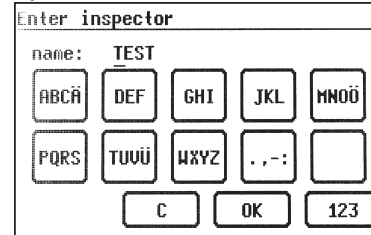

 The entered name is assigned to every test carried out and also appears in the log printout.

6.8 Activating the control code (TG euro 1 and TG euro 1 med only)

Default settings for a particular test procedure can be assigned to an appliance via a control code. A 3-digit number is entered before the ID number of the appliance, either manually or via a barcode scanner, see barcode printing and/or control code table. Press the **[C. code] function button** for this, Fig. 10.

Fig. 11

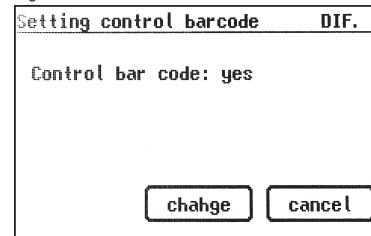

6.9 Expert mode *(TG euro 1 and TG euro 1 med only)*

The appliance tester also has an „Expert mode“. This allows advanced users to save time.

Confirmations of visual inspection, function test and switching on the test object are omitted from the test procedure.

Press the **[mode]** function button to make the setting, Fig. 11

Fig. 11a

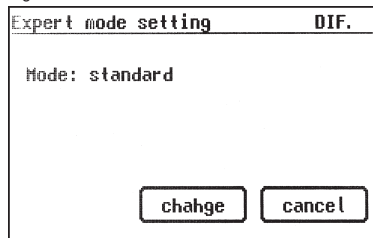

6.10 Selecting the menu language *(TG euro 1 and TG euro 1 med only)*

To select the menu language press on page 2 of the configuration menus (Fig. 12), function key **[language]** and then selecting the appropriate key for the menu language (Fig. 11b).

At the time the languages German, English, French and Italian are available.

Fig. 11b

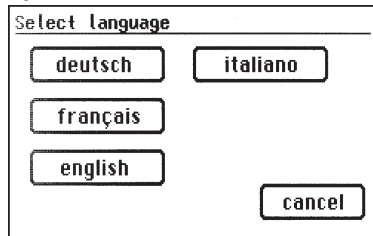

6.11 Selecting of the data memory

To save the measurement results, the appliance tester has an internal memory (16 MB) and an MMC memory card (128 MB, supplied with the tester). The memory card is used to save and/or transfer the measurement results. MMC and SD memory cards with capacities from 128 MB to 1 GB can be used.

Inserting the memory card:

Insert the memory card into the card slot with the label to the left and press gently until it engages. To eject the memory card, press it down until it disengages and pull the card upwards and out of the slot.

Caution!

Never force the memory card into the card slot of the appliance tester. This can damage the memory card and the card slot. If the memory card is not recognised, check that it has been correctly inserted.



The measurement results can be stored **either** in the internal memory **or** in the memory card.

In the configuration menu (Fig. 5) press the [menu page 2] function button and then press the **[memory]** function button (Figs. 12 and 13) to switch between the internal memory and the MMC/SD card.

The symbol in the headline changes accordingly:



Fig. 12

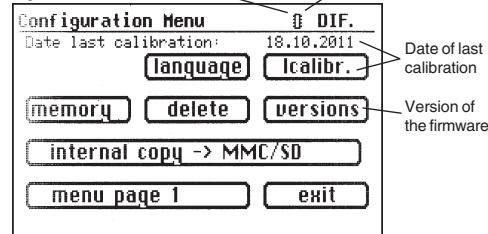
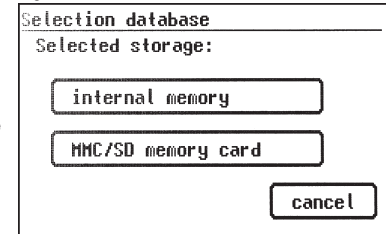

Fig. 13



If the memory card or the internal memory needs to be fully erased, then press the **[delete] function button** (Fig. 12) in the configuration menu (Page 2) and confirm the confirmation prompt.

Caution! The [delete] function permanently deletes all existing data from the internal memory or the memory card.

Use the **[internal copy -> MMC/SD] function button** (Fig. 12) to copy the internal memory to the memory card.

To read out the stored measurement results and create a test log - see the operating manual of the PC software supplied with the tester.

By pressing the **function key [KAlibr.]** the date of last calibration of the appliance tester is displayed and by pressing the **function key [Version]** the firmware version of the hardware (Fig. 12).

7. Conducting tests:

General information on DIN VDE 0701-0702:2008-06

Up to June 2008, appliances able to be disconnected from the system via plug connections were to be tested according to DIN VDE 0701 after any maintenance, repair or modification measures. Repeated tests were to be performed according to DIN VDE 0702.

The VDE 0702 standard, applicable since June 2004, states that electrical devices which are normally connected via a plug connection but are actually permanently connected must be tested according to this standard. The decisive factors for the testing / inspection interval are how the movable electrical device is used, how it is affected by the environment and how it is moved. The main consideration is always the estimation of possible danger to the user in the case of a defect.

Devices belonging to a stationary system are to be tested together with the associated system according to DIN VDE 0105-100. However, it is also possible to separate devices from a system which they are permanently connected to and test them according to the VDE 0702 „Periodic inspections“.

Point 4 of the DIN VDE 0701-0702 standard „Inspection after repair, modification of electrical appliances - Periodic inspection on electrical appliances - General requirements for electrical safety“, applicable since June 2008, clearly states that:

„A device that cannot be moved without auxiliary equipment and which is connected to an electrical system via a permanent, protected cable and which is not held in the hand when used correctly may be subjected to periodic inspection according to Point 5 (of DIN VDE 0701-702) or according to DIN VDE 0105-100 depending on the decision of the electrical professional responsible“.

In contrast to tests after repair or modification, periodic inspections usually take place on site. The device is to be disconnected from the „mains“, i.e. the electrical system, before testing. This is the only way of performing a full test on this type of device.

VDE 0701-0702 defines the sequence of tests as follows:

- Visual inspection
- Protective conductor test
- Insulation resistance measurement (where possible, not with IT devices)
- Protective conductor current
- Touch current
- Evidence of safe disconnection from the power supply circuit (SELV and PELV)
- Evidence of the effectiveness of other safety devices
- Final inspection of the inscriptions
- Function test

If the device to be tested cannot be disconnected from the electrical system, then proceed as follows:

- Visual inspection
- Measure the protective conductor resistances for protective class I devices and
- Measure the touch current on touchable, conductive parts of protective class II devices and touchable, conductive parts of protective class I devices that are not connected to the protective conductor.

8. Conducting tests:

Explanation of terminology

8.1 Touch current (I_t)

Current that can flow to earth via the person handling the device (test object).

The measurement is carried out between touchable conductive parts of the test object and the earth.

The measurement can either be made directly or with the differential current method.

A direct measurement is applicable if the test object can be insulated from earth.

In all other cases the differential current method should be used.

The touch current measurement is carried out on test objects in protection class II with touchable conductive parts, or on test objects in protection class I, which have touchable conductive parts that are not connected to the protective conductor.

 The measurement is to be carried out in both positions of the mains plug – the reversal of polarity is automatic with the appliance tester – extracting and reversing the mains plug is not necessary.

 Also see measuring principle circuits on Page 19.

8.2 Differential current (I_p)

In terms of the standards DIN VDE 0701-0702, this is the total instantaneous values of all currents flowing through all active conductors on the mains side connection of the device (test object).

The differential current method is a measuring method for determining protective conductor current or touch current.

The total leakage current of a test object can be measured. This measuring method must be applied if the test object cannot be insulated.



Also see measuring principle circuit M6 on Page 18.



Caution! The test object is supplied with mains voltage during the test.

8.3 Device leakage current (I_{GA})

Current flowing to earth (PE) from the power supply via the protective conductor and via touchable conductive parts of the housing and/or from the applied part when applied parts are conductively connected to the housing (DIN VDE 0751-1:2008-08).



Caution! The test object is supplied with mains voltage during the test.

8.3.1 Substitute leakage current (I_{EA})

Current that would flow through the interconnected active conductors of the device (test object) and the protective conductor or the touchable conductive parts at rated voltage and rated frequency of the device.

This measuring method determines the leakage current without mains voltage. It is an alternative measuring method for determining protective conductor current or touch current.



Also see measuring principle circuit M4a on Page 18.

8.3.2 Substitute device leakage current (I_{EGA})

Device leakage current measured via the alternative measuring method (new designation according to DIN VDE 0751-1:2008-08: Device leakage current - alternative measurement), see Image C4 (Page 50).

8.3.3 Device leakage current – Alternative measurement (I_{GA})

Device leakage current determined via the alternative measuring method (previously designated as substitute device leakage current).

8.3.4 Substitute patient leakage current (I_{EPA})

Patient leakage current measured via the alternative measuring method (new designation according to DIN VDE 0751-1:2008-08: Leakage current from the applied part - alternative measurement), see Image C7 (Page 51).

8.3.5 Leakage current from the applied part – Alternative measurement

Leakage current determined via the alternative measuring method (previously designated as substitute patient leakage current).

8.3.6 Patient leakage current (I_{PA})

Current flowing from the applied part through the patient to earth, or current caused by an unforeseen foreign voltage at the patient and which flows through the patient and an applied part of Type F to earth (DIN VDE 0751-1:2008-08). In the latest issue of DIN VDE 0751-1, the leakage current from the applied part is measured instead of the patient leakage current.

8.3.7 Leakage current from the applied part

Current flowing from the power supplies and touchable conductive parts to the applied part.

8.3.8 Patient leakage current – Mains voltage at the applied part

Patient leakage current determined by applying an auxiliary voltage between the mains protective conductor (and housing parts) and the applied part (new designation according to DIN VDE 0751-1:2008-08: Leakage current from the applied part - mains voltage at the applied part).

8.3.9 Leakage current from the applied part – Mains voltage at the applied part

Leakage current determined by applying an auxiliary voltage between the mains protective conductor (and housing parts) and the applied part (previously designated as patient leakage current - mains voltage at the applied part).

8.4 Insulation resistance (R_{ISO})

Ohmic resistance between the conductive parts separated by insulation. Measurements are taken between the active parts and the body as well as touchable conductive parts that are not connected to the protective conductor.

 Also see measuring principle circuits on Page 17.

8.5 Protective measures

When defining the test procedures, a distinction is no longer made according to the protection class as previously but rather the existing protective measures of the test object are taken into consideration and their effectiveness at the respective touchable conductive part is to be verified. The appliance tester makes the following classifications:

8.5.1 Devices with a protective earth connector (PC I)

The active parts of the device are protected against direct touching by the basic insulation. Through connection of the touchable conductive housing parts to the protective conductor, these are included in the protective measure in the case of indirect touching (fault protection) with the system. The residual current is measured via the protective conductor current measurement.

The device may also have touchable conductive parts that are not connected to the protective conductor. The residual current is measured via the touch current measurement.

The device has a protective conductor connection (earthed plug).

8.5.2 Devices without a protective earth connector (PC II)

The active parts are separated by strengthened or double insulation (basic insulation and additional insulation). This ensures protection against direct contact.

Protection against indirect contact is also given, since an insulation fault is practically impossible. Such devices can nevertheless have touchable metallic housing parts. Devices of protection class II have a mains plug without an earth contact.

8.5.3 Devices connected to protective extra-low voltage electric circuits (PC III)

Devices of protection class III are exclusively connected to protective extra-low voltage electric circuits - SELV / PELV.

The protection against dangerous body currents is achieved by the low voltage and the safe separation from other electric circuits.

8.6 Protective conductor current (I_{pe})

Current that flows through the protective conductor of protection class I devices (test objects) when their bodies are insulated from earth.

A direct measurement is applicable if the test object can be insulated from earth.

In all other cases the differential current method should be applied, see Point 6.3 (Basic settings of the tester, Page 10).

 Also see measuring principle circuits on Page 18.



Caution! The test object is supplied with mains voltage during the test.

8.7 Protective conductor resistance (R_{pe})

Resistance between any conductive touchable parts, connected to the protective conductor for protective purposes, and the earthed contact of the mains plug, the device plug or the protective conductor, which is constantly connected to the mains power supply.

During the measurement of the protective conductor resistance, the connecting cable should be moved, section by section, along its whole length. This measuring method only applies for devices of protection class I.

 Also see measuring principle circuit M1 on Page 17.

8.8 Visual inspection

Testing in accordance with DIN VDE 0701-0702 also requires visual inspection of the device.

According to the standard, the devices should be inspected for external defects (without opening the device) and, as far as possible, for suitability to the place of installation. In particular, attention should be paid to the following:

- Damage to the housing
- Defects of the cord connector guard and strain relief fittings
- External damage of the connecting cables
- Unauthorised interference and changes
- Signs of overloading and improper use
- Orderly condition of the protective covers
- Safety impairing soiling and corrosion
- Unblocked cooling vents
- Existence of necessary air filters
- Leak tightness, pressure relief valve
- Legibility of safety-related inscriptions
- Fuse links in accordance with manufacturer's specifications

 **Externally visible defects, which could lead to a mechanical or fire hazard should be repaired immediately.**

9. Conducting tests in accordance with DIN VDE 0701-0702: Definition of standards

The sequence of tests is specified in the standard.

9.1 Visual inspection

The test objects are inspected for externally visible defects.

9.2 Measuring the protective conductor resistance (for devices of protection class I)

The limit value is:

0.3 Ω for devices with connecting cables up to 5 m,
 plus 0.1 Ω for every extra 7.5 m, up to a maximum of
 1.0 Ω .

Measuring principle circuit
 Protective conductor resistance PC I, Diagram M1

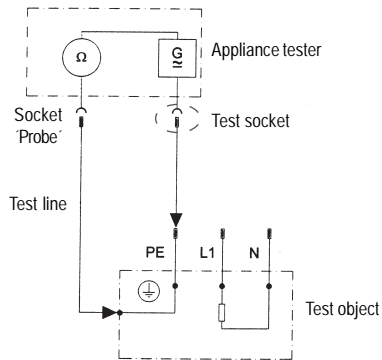

9.3 Measuring insulation resistance

The limit value is:

- 1 M Ω** for devices of protection class I
- 2 M Ω** for devices of protection class II ¹⁾
- 0.25 M Ω** for devices of protection class III
- 0.3 M Ω** for devices of protection class I
 with switched-on heating elements ²⁾

- ¹⁾ Also applies for touchable conductive parts of test objects in protection class I that are not connected to the protective conductor.
- ²⁾ If the required insulation resistance is not achieved in the case of test objects in protection class I with heating elements with a total capacity $e^* 3.5$ kW, the test object is nevertheless rated as faultless if the protective conductor current does not exceed the limit values.

Measuring principle circuit
 Insulation resistance PC I, Diagram M2

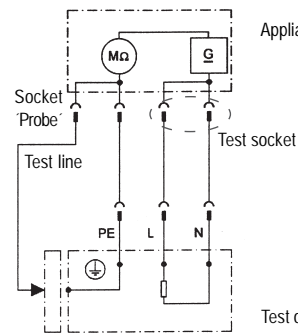

PC II and III, Diagram M3

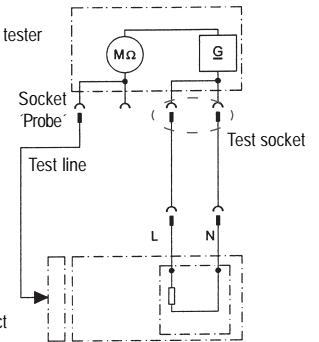

9.4.1 Measuring the protective conductor current
 (with devices of protection class I)

The limit value is 3.5 mA.

The protective conductor current for test objects with heating elements having a total connected power greater than 3.5 kW must not be greater than 1 mA/kW heating power, up to a maximum value of 10 mA. The protective conductor current can either be measured directly with the substitute leakage current method or with the differential current method.

Measuring principle circuits

Protective conductor current – substitute leakage current method PC I, Diagram M4a

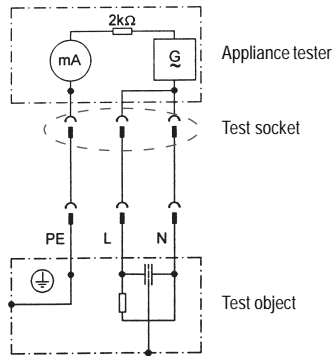

Caution! The test object is supplied with mains voltage during the test!

Protective conductor current – direct measurement PC I, Diagram M5

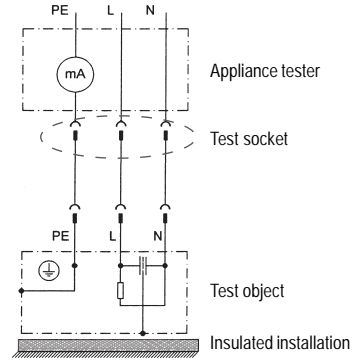

Protective conductor current – differential current method PC I, Diagram M6

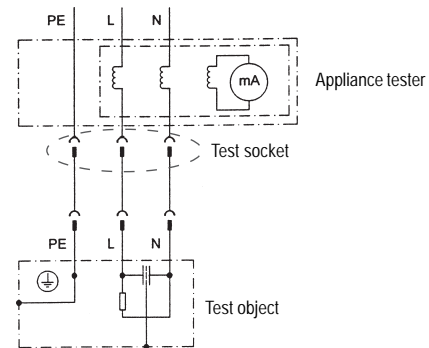

In the case of test objects in PC I with touchable conductive parts that are not connected to the protective conductor, an additional touch current measurement must be carried out according to PC II (see Diagram 1 on Page 20).

9.4.2 Measuring touch current (for devices of protection class II)

The limit value is 0.5 mA

The touch current can either be measured directly with the substitute leakage current method or with the differential current method. This measurement must also be carried out on devices of protection class I with touchable conductive parts.

Measuring principle circuits
 Touch current – substitute leakage current method PC II, Diagram M4b

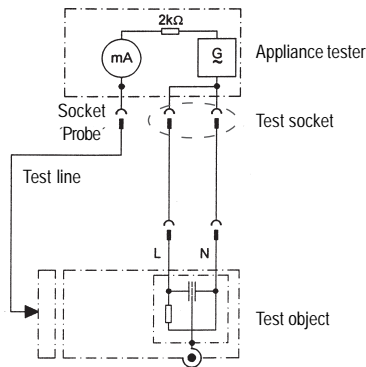

Caution! The test object is supplied with mains voltage during the test!

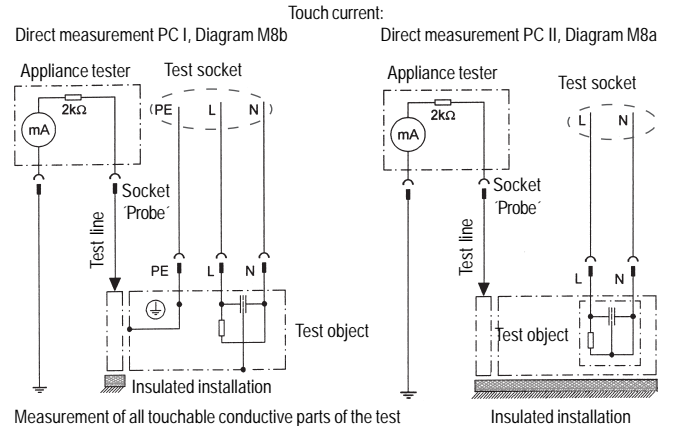

Measurement of all touchable conductive parts of the test object that are not connected to the protective conductor

9.5 Inspecting the inscriptions

Safety-related inscriptions must be controlled and, where necessary, renewed or supplemented in suitable form.

9.6 Function test

After completion of the electrical test, a function test shall be carried out on the test object. A partial test can be sufficient.

9.7 Documentation

Once a test is passed, it must be documented in a suitable form. If a test object proves to be unsafe, this should be clearly indicated on the device and the operator informed in writing. Recording the measured values and the changes is recommended.

9.8 Diagram 1
Test procedure for devices
with protective conductor (PC I)

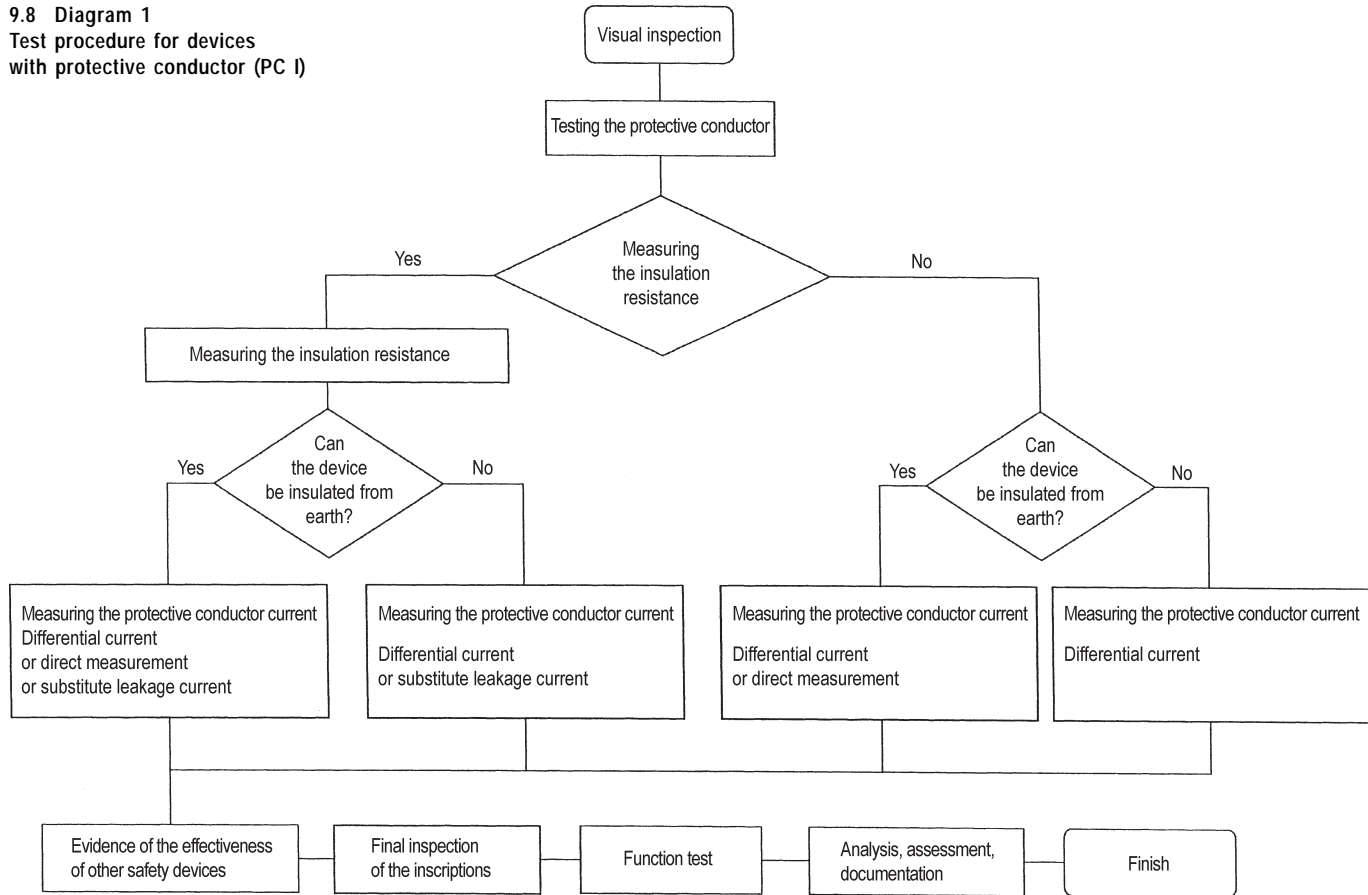

9.9 Diagram 2
 Test procedure for devices
 without protective conductor (PC II)

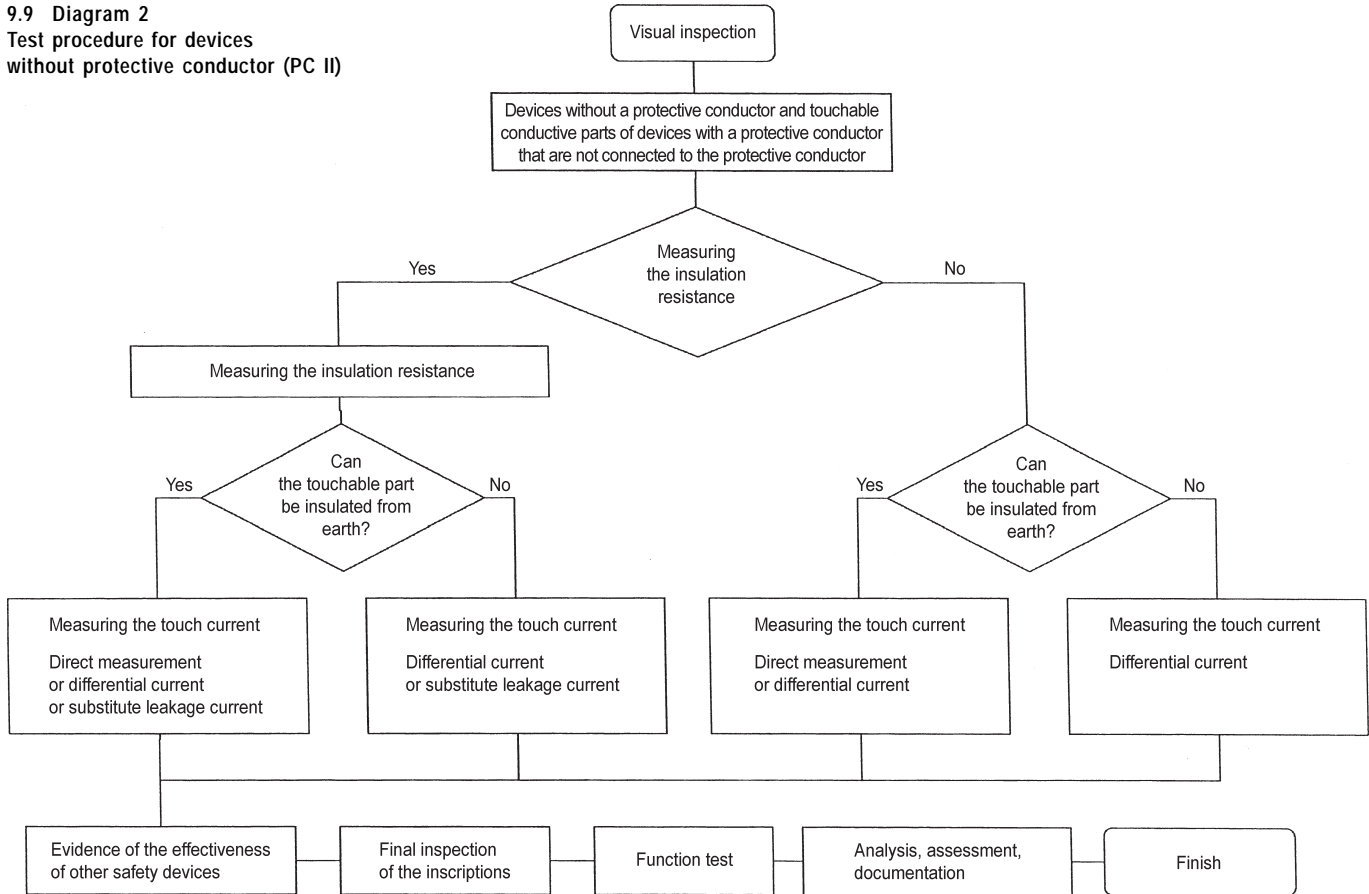

**10. Conducting tests with the appliance tester:
according to DIN VDE 0701-0702, Example 1 - Devices with
a protective conductor (PC I)**

Connecting the test object

- Connect one end of the test line to the probe socket of the appliance tester.
- Use the crocodile clip to connect the other end of the test line with a metal part of the test object, which is connected to the protective conductor. Ensure that the crocodile clip makes a good contact with the metal part of the test object.
- Connect the mains plug of the test object to the test socket of the appliance tester.
- Switch on the test object with the mains switch.

Switching on the appliance tester

Connect the mains plug of the appliance tester to a properly connected and functional earthed mains socket. Switch on the appliance tester via the mains switch. Press the large button in the switch-on display (Fig. 14). The currently set parameters are displayed in the next screen. These can be changed, or simply confirmed using the [next] button (Fig. 15).

 Please note that the device does not have a real time clock. The date must be entered anew or accepted.

Pressing the [next] button brings you to the Main menu (Fig. 16). Here you can select the „Appliance testing“ mode, or select [Indiv. tests (service)] to (e.g.) individually perform each test for servicing purposes or select the basic settings of the appliance tester via the [Configuration] button (see Page 9 Point 6.1).

DIN VDE 0751/EN 62353 at TG euro 1 med only

Fig. 14

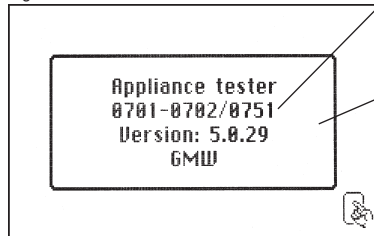

Fig. 15

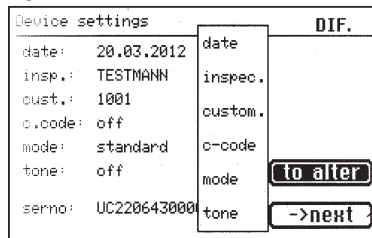
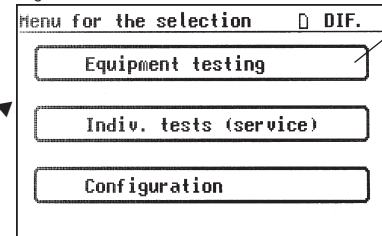

Fig. 16



Entering the appliance identification

Press the [Appliance testing] button in the Main menu (Fig. 16). A screen is displayed requesting entry of the appliance identification. Pressing the [1/A] button changes the display to a keypad (Fig. 17) allowing the entry of a test object ID number with a maximum of 19 digits. This can also be read via a barcode scanner.

The subsequent entry of the appliance type (Fig. 19) is not compulsory and is automatically displayed for barcode entry. For manual entry you use the [1/A] and [OK] buttons to reach this menu. Press the [OK] button if you do not wish to enter any information here.

In the Main menu (Fig. 20) press the [to DIN VDE 0701-0702] button.

 Entry of the appliance identification number is not compulsory.

Fig. 17

Fig. 18

Fig. 19

Fig. 20

Operating manual for the TG uni 1, TG euro 1 and TG euro 1 med appliance tester

Conducting tests in accordance with DIN VDE 0701-0702, Example 1 – Devices with a protective conductor (PC I)

Test settings

Fig. 21 shows the Main menu for test object protective measures. After selecting the protective measure by pressing the [device with PE (PcI)] button you reach the „Test device with PE“ menu (Fig. 22).

- [test general] function:
The test procedure contains all measurements required by the VDE 0701- 0702 standard.
- [test cables] function:
This only measures the protective conductor resistance and insulation resistance.
- [appl. with heating elements] function:
The test procedure contains all measurements required by the VDE 0701- 0702 standard using the limit values defined in the standard for this class of appliance.

After pressing the [test general] button you reach the „Settings for measuring“ menu (Fig. 23).

You use the [IEA/IPE] button to define whether or not substitute leakage current measurement is to be used for determining the protective conductor or touch current.

Use the [R_{ISO} y/n] button to define whether the insulation resistance is to be tested or not.

The [PE ≤ 5.0 m] button defines the length of the test object's connecting cable. With every press on this button the value is increased by a further 7.5 m.

The resulting limit values for the maximum protective conductor resistance can be seen in the limit value line, see also the table below:

Length of the connection cable (of the PE protective conductor) up to	Limit value for protective conductor resistance (R _{PE})
5.0 m	0.3 Ω
12.5 m	0.4 Ω
20 m	0.5 Ω
27.5 m	0.6 Ω
35 m	0.7 Ω
42.5 m	0.8 Ω
50 m	0.9 Ω
>50m	1.0 Ω

With the function button [hand/auto] you determine whether the test procedure should be carried out manually (by hand) or automatically.

The headline (upper right) shows the setting:

Manually by hand (m), automatic (a)

Fig. 21

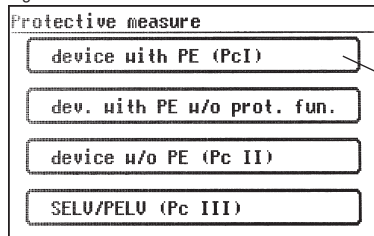

Fig. 22

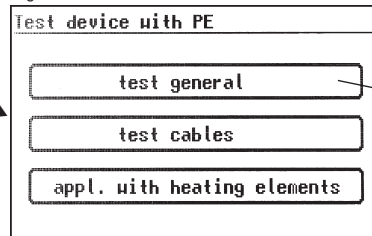
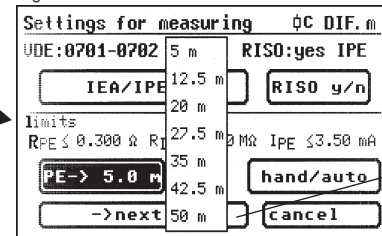



Fig. 23



 Manual test procedure means that you have to confirm every test stage by pressing the [OK] button to get to the next test stage. Automatic test procedure means that a test stage automatically changes to the next after (e.g.) 5 seconds – except for confirmation of connection to the mains voltage (see Point 6.6, basic settings of the appliance tester).

The [cancel] button takes you back to the Main menu. To move to the next stage press the [->next] button (also see Diagram 1 in Point 9.8).

10.1 Visual inspection

The [next] button takes you to the first stage of the test, the visual inspection (Fig. 24).

The housing, connecting cable, inscriptions and other parts should be inspected in this test. You confirm positive results of the visual inspection by pressing the appropriate buttons – the display changes from „not OK“ to „OK“ (Fig. 25).

 Please note: The visual inspection screen is not displayed in „Expert mode“ (TG euro 1 and TG euro 1 med only).

If the test object has touchable conductive parts that are not connected to the protective conductor, then a touch current test must be performed (Fig. 26).

 For all subsequent tests, the test object must be switched on.

Pressing the [next] button brings the device to PE resistance test screen (Fig. 27).

Fig. 24

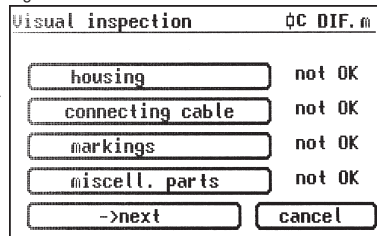

Fig. 25

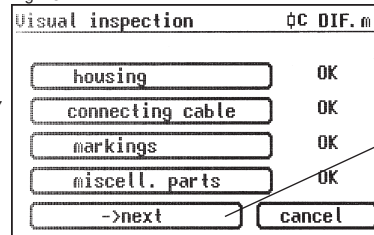
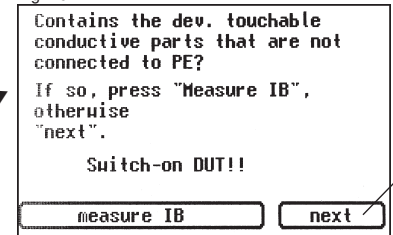

Fig. 26



Operating manual for the TG uni 1, TG euro 1 and TG euro 1 med appliance tester

Conducting tests in accordance with DIN VDE 0701-0702, Example 1 – Devices with a protective conductor (PC I)

10.2 Protective conductor resistance

The limit value is:

0.3 Ω for devices with connecting cables up to 5 m,
plus 0.1 Ω for every additional 7.5 m, up to a maximum of
1.0 Ω (see also table on Page 24).

The [next] button takes you to the first electrical test: the protective conductor resistance (Fig. 27).

The measured value is displayed in large text in the middle of the screen.

 The star sign on the left side of the display blinks when the measuring process is running (the values are being measured). The [OK] button appears when the measured value is determined.

The corresponding limit value „Lv“ and the momentary test current (+) are also displayed.

You can display the help screen by pressing the [help] button. A measuring principle circuit corresponding to the figure in this operating manual and a short help text are displayed. After pressing the [End] button you return to the measuring display.

In the next stage the polarity of the test current (-) is reversed and the protective conductor resistance is measured again.

 During the measurement, the connecting cable of the test object should be moved, section by section, along its whole length, in order to find broken conductors or weak points.

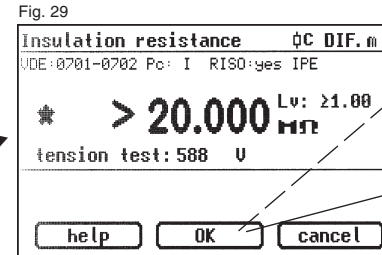
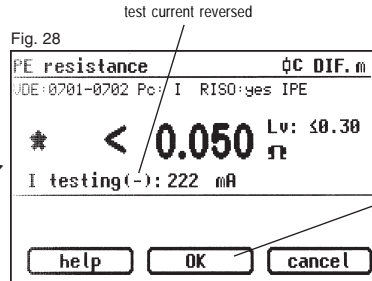
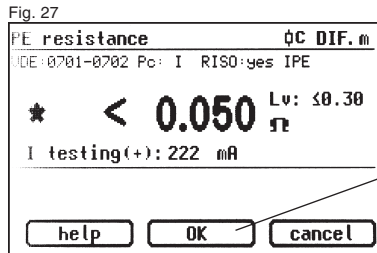

10.3 Insulation resistance (compare with point 10.41)

The limit value is:

1.0 M Ω (PC I)
2.0 M Ω for touchable conductive parts that are not connected to the protective conductor (PC I)
0.3 M Ω for PC I devices with switched on heating elements
≥ 3.5 kW *)

*) If the required insulation resistance is not achieved in the case of devices in protection class I with heating elements with a total capacity of 3.5 kW, the device is nevertheless rated as faultless if the protective conductor current does not exceed the limit values (tester setting – PC: Ie).

If you have selected a test procedure **with insulation resistance** in the „Settings for measuring“ screen, the measuring display for the insulation resistance measurement (Fig. 29) appears after you press the [OK] button. The magnitude of the test voltage is displayed as well as the measured value (minimum of 500 V DC).

 The star sign on the left side of the display blinks when the measuring process is running (the values are being measured). The [OK] button appears when the measured value is determined.

A help display with a measuring principle circuit and a help text is also available here.

10.4.1 Protective conductor current (substitute leakage current)

The limit value is:

3.5 mA (PC I)

The protective conductor current for devices with heating elements having a total power greater than 3.5 kW must not be greater than 1 mA/kW heating power, up to a maximum value of 10 mA.

The [OK] button takes you further to the measuring display „Protective conductor current“ (according to the substitute leakage current method). Here, too, the corresponding limit value is displayed beside the measured value (Fig. 30).

Fig. 30

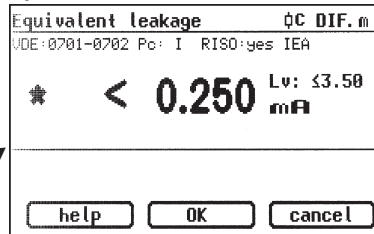

10.4.2 Protective conductor current (compare with Point 10.41)

The limit value is:

3.5 mA (PC I)

The protective conductor current for devices with heating elements having a total power greater than 3.5 kW must not be greater than 1 mA/kW heating power, up to a maximum value of 10 mA.

If you have selected a test procedure **without insulation resistance** in the „Settings for measuring“ screen, the tester changes to measuring the protective conductor current (Points 3 - Insulation resistance and 4a - Substitute leakage current, are omitted).



Caution! The test object is supplied with mains voltage during the test.

After pressing the [OK] button you will see a warning about the connection to the mains voltage (Fig. 31).

Fig. 31

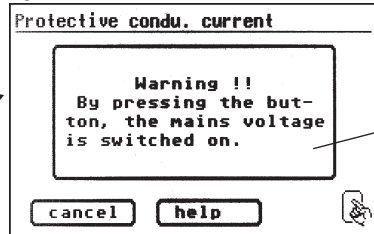

Fig. 32

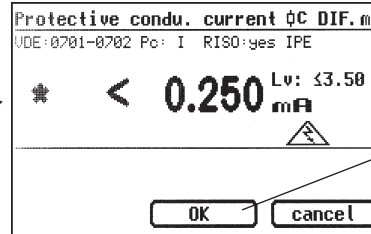
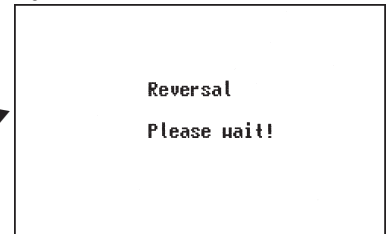

Fig. 33





Operating manual for the TG uni 1, TG euro 1 and TG euro 1 med appliance tester

Conducting tests in accordance with DIN VDE 0701-0702, Example 1 – Devices with a protective conductor (PC I)

With your assent – by pressing the large button – the display changes to measuring the protective conductor current and the mains voltage is connected – **the test object is put into operation!**

You can see the measured value in the middle of the display, with the related limit value to the right (Fig. 32).

 The star sign on the left side of the display blinks when the measuring process is running (the values are being measured). The [OK] button appears when the measured value is determined.

The symbol  blinks to indicate the connection to the mains voltage.

With the [help] button, you can also go to the help display from here.

Pressing the [OK] button automatically **reverses the polarity** of the mains plug of the test object (Fig. 33).

The switching pause provides time for any running motors to stop. Thereafter, you are again warned about the connection to the mains voltage. After pressing the [OK] button, the mains voltage is switched on once more and the protective conductor current is measured again.

 Selecting the measuring method for protective conductor current – see Point 6.3 Setting the measuring method for protective conductor current measurement.

Fig. 34

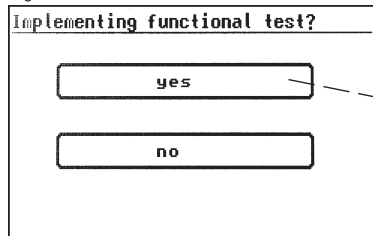

Fig. 35

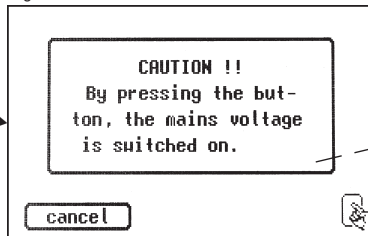
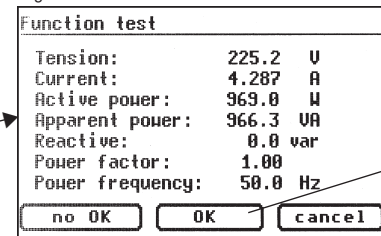

Fig. 36



10.5 Function test

Press the [OK] button to go to the „Function test“ menu.



Caution! The test object is supplied with mains voltage during the test.

Before the mains voltage is connected a warning message may appear in the display. The automatic test procedure is stopped; it only proceeds when a button is pressed (Fig. 35).

After you have confirmed execution of the function test by pressing the button, the appliance tester changes over to the function test display (Fig. 36).

The display shows the instantaneous mains voltage, the load current, the active power, apparent power and reactive power, the power factor and mains frequency.

10.6 Inspecting the inscriptions

At this point the values displayed in the function test should be compared with the data on the type plate of the test object.

10.7 Documentation

After pressing the [OK] button, the display changes to the „Test result“ screen (Fig. 37).

Here you can see all the measurement results with the related limit values.

If the measurement results of the electrical values, the visual inspection and the function test were all in order, the following message appears:

“Test OK”.

If the test was not successful the message says:

“Test not OK!”.

At this point you can cancel the test with the [cancel] button (the display goes back to the „Settings for measuring“ screen) or switch to the „Memory menu“ with the [next] button.

In the „Memory menu“ (Fig. 38) you can confirm or modify the following parameters: device ID number, device designation, name of the inspector, date and customer number.

You can also change the storage location – from internal memory to MMC/SD card and vice-versa.

The current setting is displayed via a symbol in the headline of the memory menu.



The appliance identification can also be read from a barcode label using the optional barcode scanner.

To do this, before starting up the appliance tester connect the plug of the barcode scanner to the RS232 socket of the tester and screw it tight.

Symbols for memory settings:



– Internal memory



– MMC/SD memory card

Fig. 37

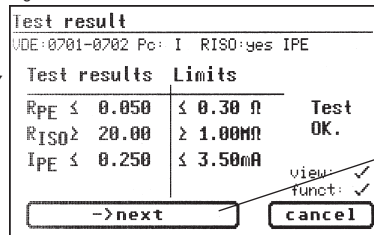

Fig. 38

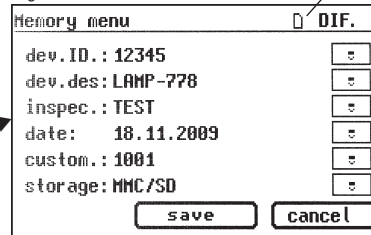
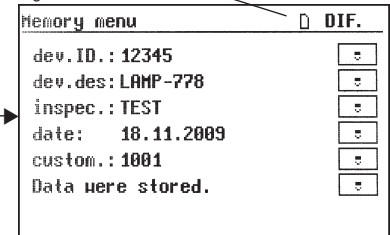

Fig. 39



Operating manual for the TG uni 1, TG euro 1 and TG euro 1 med appliance tester

Conducting tests in accordance with DIN VDE 0701-0702, Example 1 – Devices with a protective conductor (PC I)

You confirm the entries by pressing the [save] button – a „Data were stored“ message is displayed briefly and the display changes to Fig 39. With the entry of an already used ID number, the data is „attached“ as a new test to this ID number.

After saving, the display changes to the screen for entering the ID number – the appliance tester is now ready for another test (Fig. 40).

The test results can be saved on a PC with the supplied PC program or printed from there in the form of a test log. To do this, establish the USB connection between the appliance tester and the PC* (USB cable supplied) or directly copy the saved data from the memory card to the PC using a card reader.

Procedure on the PC – see the operating instructions for the PC software.

- * Switch the appliance tester off and on, leave the switch-on message as it is (Fig. 41). Connect the USB cable. The appliance tester is automatically detected by Windows® as removable media. The internal memory is assigned to the first free drive letter and the memory card is assigned to the second free drive letter.

General information

Every test stage during which the test object is supplied with mains voltage is time limited for reasons of safety.

The maximum duration of this test stage is approx. 5 minutes. This means that the appliance tester will not remain in a state where the test object is supplied with mains voltage for longer than approx. 5 minutes.

After this time, the mains voltage is switched off and an appropriate message is shown in the display.

At this point you can continue the test with the [next] button or cancel it with the [cancel] button.

DIN VDE 0751/EN 62353 at TG euro 1 med only

Fig. 40

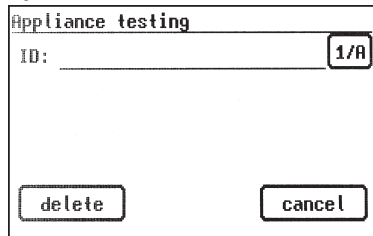

Fig. 41

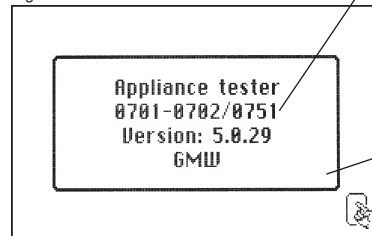
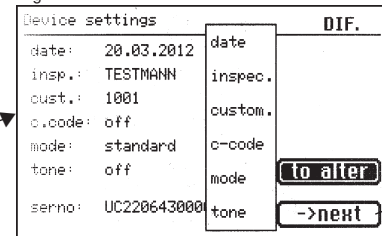

Fig. 42



**11. Conducting tests with the appliance tester:
according to DIN VDE 0701-0702, Example 2 - Devices without
a protective conductor (PC II)**

Connecting the test object

- Connect one end of the test line to the probe socket of the appliance tester.
- Use the crocodile clip to connect the other end of the test line with a touchable conductive part of the housing of the test object. Make sure that the crocodile clip makes a good contact.
- Connect the mains plug of the test object to the test socket of the appliance tester.
- Switch on the test object with the mains switch.

Switching on the appliance tester

Connect the mains plug of the appliance tester to a properly connected and functional earthed mains socket. Switch on the appliance tester via the mains switch. Press the large button in the switch-on display (Fig. 41). The currently set parameters are displayed in the next screen. These can be changed, or simply confirmed using the [next] button (Fig. 42).

 Please note that the device does not have a real time clock. The date must be entered anew or accepted.

Pressing the [next] button brings you to the Main menu (Fig. 43). Here you can enter the „Appliance testing“ mode - [Indiv. tests (service)] button or configure the basic settings of the appliance tester - [Configuration] button (see Page 9 Point 6.1).

Entering the appliance identification

Press the [Appliance testing] button in the Main menu (Fig. 43). A screen is displayed requesting entry of the appliance identification. Pressing the [1/A] button changes the display to allow the entry of a test ID number with a maximum of 19 digits. This can also be read via a barcode scanner.

 Entry of the appliance identification number is not compulsory.

The subsequent entry of the appliance type (Fig. 46) is not compulsory and is automatically displayed for barcode entry. For manual entry you use the [1/A] and [OK] buttons to reach this menu.

Press the [OK] button if you do not wish to enter any information here.

Fig. 43

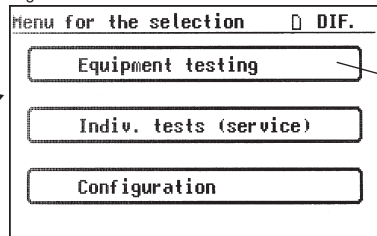

Fig. 44

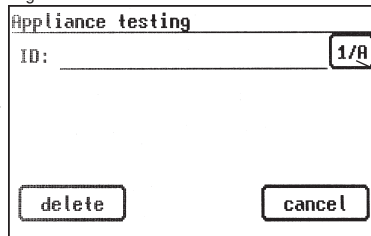
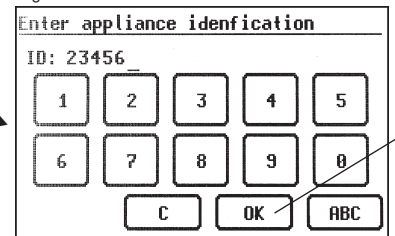

Fig. 45



Operating manual for the TG uni 1, TG euro 1 and TG euro 1 med appliance tester

Conducting tests in accordance with DIN VDE 0701-0702, Example 2 – Devices without a protective conductor (PC II)

Test settings

Fig. 47 shows the Main menu for test object protective measures. After selecting the protective measures by pressing the [device w/o PE (Pc II)] function button you reach the „Settings for measuring“ menu (Fig. 48).

You use the [IEA/IPE] button to define whether or not substitute leakage current measurement is to be used for determining the touch current.

Use the [RISO y/n] button to define whether the insulation resistance is to be tested or not.

With the function button [hand/auto] you determine whether the test procedure should be carried out manually (by hand) or automatically.

The headline (upper right) shows the setting: Manually by hand (m), automatic (a)



Manual test procedure means that you have to confirm every test stage by pressing the [OK] button to get to the next test stage. Automatic test procedure means that a test stage automatically changes to the next after 5 seconds – except for confirmation of connection to the mains voltage (see Point 6.6, basic settings of the tester).

The [cancel] button takes you back to the Main menu. To move to the next stage press the [next] button (also see Diagram 1 in Point 9.8).

DIN VDE 0751/EN 62353 at TG euro 1 med only

Fig. 46

Appliance testing

ID: 23456

1/A

to DIN VDE 0701-0702

to EN 62353

delete

cancel

Fig. 47

Protective measure

device with PE (Pc I)

dev. with PE w/o prot. fun.

device w/o PE (Pc II)

SELV/PELV (Pc III)

Fig. 48

Preference test

QC DIF. m

VDE:0701-0702 Pc: II RISO:yesIEA

IEA/IPE

RISO y/n

Limits

RISO >= 2.00M Ohm IEA <= 0.50 mA

hand/auto

>-next

cancel

11.1 Visual inspection

The [next] button takes you to the first stage of the test, the visual inspection (Fig. 50).

The housing, connecting cable, inscriptions and other parts should be inspected in this test. You confirm a positive result for the visual inspection by pressing the corresponding button – the display changes from „not OK“ to „OK“ (Fig. 51).

 Please note: The visual inspection screen is not displayed in „Expert mode“.

 For all subsequent tests, the test object must be switched on.

Pressing the [next] button brings the device to the Insulation resistance test screen (Fig. 53).

Fig. 49

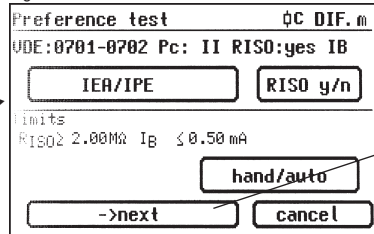

Fig. 50

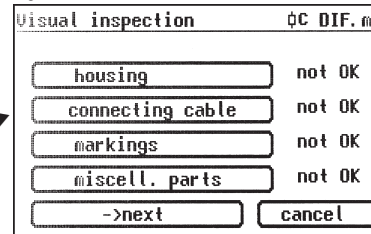
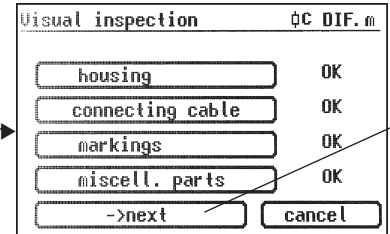

Fig. 51



Operating manual for the TG uni 1, TG euro 1 and TG euro 1 med appliance tester

Conducting tests in accordance with DIN VDE 0701-0702, Example 2 – Devices without a protective conductor (PC II)

11.2 Insulation resistance

The limit value is:
2.0 M Ω (PC II)

If you have selected a test procedure with **insulation resistance** in the „Settings for measuring“ screen, the measuring display for insulation resistance measurement (Fig. 53) appears after you press the [next] button. The magnitude of the test voltage is displayed as well as the measured value (minimum of 500 V DC).

 The star sign on the left side of the display blinks when the measuring process is running (the values are being measured). The [OK] button appears when the measured value is determined.

By pressing the [help] button you go to a help display with the measuring principle circuit and a help text.

11.3.1 Touch current (substitute leakage current)

The limit value is:
0.5 mA

This measurement must also be carried out on devices of protection class I with touchable conductive parts that are not connected to the protective conductor.

Press the [OK] button to go to the „Touch current“ measuring display. The measurement is performed using the substitute leakage current principle (when selected). Here, too, the corresponding limit value is displayed beside the measured value (Fig. 54).

 The star sign on the left side of the display blinks when the measuring process is running (the values are being measured). The [OK] button appears when the measured value is determined.

A help display is also available if you press the [help] button.

Warning!

With the test procedure **without insulation resistance**, the appliance tester measures the **touch current** with connection to the **mains voltage** (direct method or according to the differential current principle).

Fig. 52

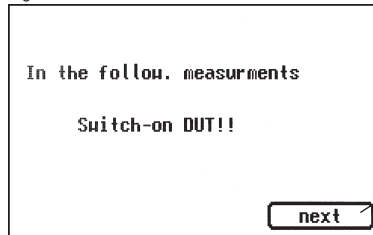

Fig. 53

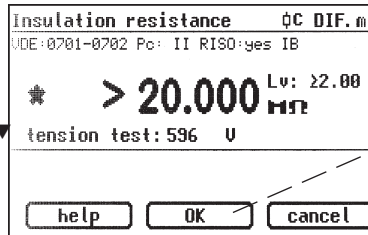
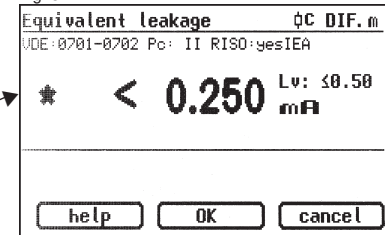

Fig. 54



11.3.2 Touch current (direct or differential current)

The limit value is:

0.5 mA

This measurement must also be carried out on devices of protection class I with touchable conductive parts that are not connected to the protective conductor.

If you have selected a test procedure **without insulation resistance** in the „Settings for measuring“ screen, the appliance tester changes to measuring the touch current (Points 11.2. Insulation resistance and 11.3a. Touch current / Substitute leakage current, are omitted).



Caution! The test object is supplied with mains voltage during the test.

After pressing the [next] button the display changes and you receive a warning message about the connection to the mains current (Fig. 55). With your assent – by pressing the large button – the display changes to measuring the touch current and the mains voltage is connected – **the test object is put into operation!**

You can see the measured value in the middle of the display, with the related limit value to the right (Fig. 56).



The star sign on the left side of the display blinks when the measuring process is running (the values are being measured). The [OK] button appears when the measured value is determined.

The symbol blinks to indicate the connection to the mains voltage.

With the [help] button, you can also go to the help display from here.

Pressing the [OK] button automatically **reverses the polarity** of the mains plug of the test object (Fig. 57).

The switching pause provides time for any running motors to stop. Thereafter, you are again warned about the connection to the mains voltage. After confirmation by pressing the button, the mains voltage is switched on once more and the touch current is measured again.



Selecting the measuring method for touch current – see Point 6.3, Setting the measuring method for protective conductor current measurement.

Fig. 55

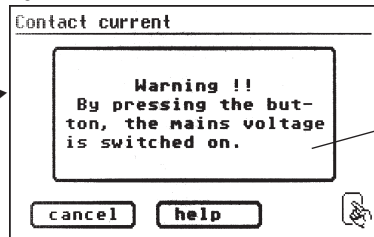

Fig. 56

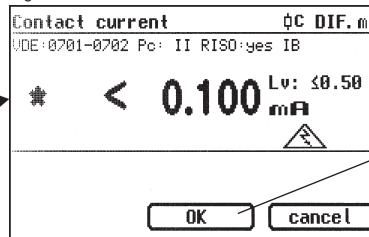
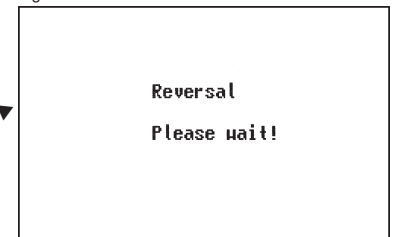

Fig. 57



Operating manual for the TG uni 1, TG euro 1 and TG euro 1 med appliance tester

Conducting tests in accordance with DIN VDE 0701-0702, Example 2 – Devices without a protective conductor (PC II)

11.4 Function test

Press the [OK] button to go to the function test. A function test of the test object is performed here (Fig. 58).



Caution! The test object is supplied with mains voltage during the function test.

Before the mains voltage is connected a warning message may appear in the display. The automatic test procedure is stopped; it only proceeds when a button is pressed (Fig. 59).

After you have confirmed switching on of the mains voltage by pressing the button, the appliance tester changes over to the function test display (Fig. 60).

The display shows the instantaneous mains voltage, the load current, the active power, apparent power and reactive power, the power factor and mains frequency.

11.5 Inspecting the inscriptions

At this point the values displayed in the function test should be compared with the data on the type plate of the test object.

11.6 Documentation

After pressing the [OK] button, the display changes to the „Test result“ screen. Here you can see all the measurement results with the related limit values (Fig. 61).

If the measurement results of the electrical values, the visual inspection and the function test were all in order, the following message appears:

„Test OK“.

If the test was not successful the message says:

„Test not OK!“.

At this point you can cancel the test with the [cancel] button (the display goes back to the „Settings for measuring“ screen) or switch to the „Memory menu“ with the [next] button.

Fig. 58

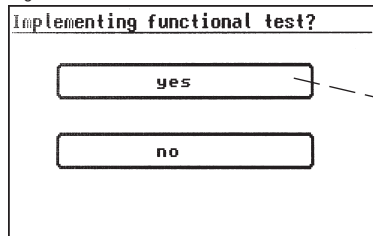

Fig. 59

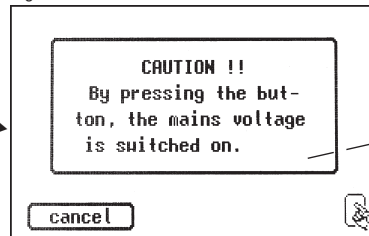
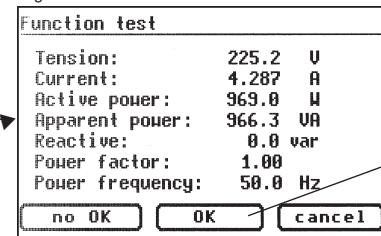



Fig. 60



In the „Memory menu“ (Fig. 62) you can confirm or modify the following parameters: device ID number, device designation, name of the inspector, date and customer number.

You can also change the storage location – from internal memory to MMC/SD card and vice-versa.

The current setting is displayed via a symbol in the headline of the memory menu.

 The appliance identification can also be read from a barcode label using the optional barcode scanner. To do this, before starting up the appliance tester connect the plug of the barcode scanner to the RS232 socket of the tester and screw it tight.

You confirm the entries by pressing the [save] button – a „Data were stored“ message is displayed briefly and the display changes to Fig 63. With the entry of an already used ID number, the data is „attached“ as a new test to this ID number. After saving, the display changes to the screen for entering the ID number – the appliance tester is now ready for another test (Fig. 63).

The test results can be saved on a PC with the supplied PC program or printed from there in the form of a test log. To do this, make the USB connection between the appliance tester and the PC* (USB cable supplied with the tester) or transfer the saved data from the memory card to the PC.

Procedure on the PC – see the operating instructions for the PC software.

* Switch the appliance tester off and on, leave the switch-on message as it is (Fig. 41). Connect the USB cable. The appliance tester is automatically detected by Windows® as removable media. The internal memory is assigned to the first free drive letter and the memory card is assigned to the second free drive letter.

General information

Every test stage during which the test object is supplied with mains voltage is time limited for reasons of safety.

The maximum duration of this test stage is approx. 5 minutes. This means that the appliance tester will not remain in a state where the test object is supplied with mains voltage for longer than approx. 5 minutes.

After this time, the mains voltage is switched off and an appropriate message is shown in the display.

At this point you can continue the test with the [next] button or cancel it with the [cancel] button.

Symbols for memory settings:



-  – Internal memory
-  – MMC/SD memory card

Fig. 61

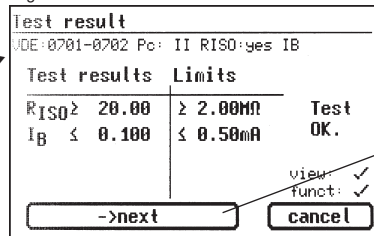

Fig. 62

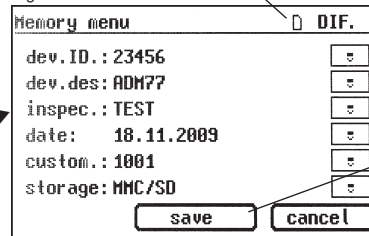
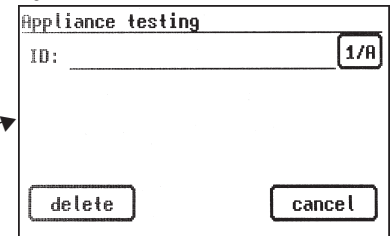

Fig. 63



Operating manual for the TG uni 1, TG euro 1 and TG euro 1 med appliance tester

Conducting tests in accordance with DIN VDE 0701-0702, Example 3 – Devices with SELV / PELV (PC III)

12. Conducting tests with the appliance tester: according to DIN VDE 0701-0702, Example 3 - Devices with SELV / PELV (PC III)

Connecting the test object

- Connect one end of the test line to the probe socket of the appliance tester.
- Use the crocodile clip to connect the other end of the test line with a touchable metal part of the housing of the test object. Ensure that the crocodile clip makes a good contact with the metal part of the test object.
- Connect the mains power connector of the test object with the test socket of the appliance tester (see Diagram M3 on Page 17).
- Switch the test object on.

Switching on the appliance tester

Connect the mains plug of the appliance tester to a properly connected and functional earthed mains socket. Switch on the appliance tester via the mains switch. Press the large button in the switch-on display (Fig. 64). The currently set parameters are displayed in the next screen. These can be changed, or simply confirmed using the [next] button (Fig. 65).

 Please note that the device does not have a real time clock. The date must be entered anew or accepted.

Pressing the [next] button brings you to the Main menu (Fig. 66). Here you can select the „Appliance testing“ mode, or select [Indiv. tests (service)] to (e.g.) individually perform each test for servicing purposes or select the basic settings of the appliance tester via the [Configuration] button (see Page 9 Point 6.1).

DIN VDE 0751/EN 62353 at TG euro 1 med only

Fig. 64

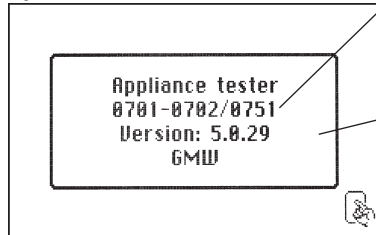

Fig. 65

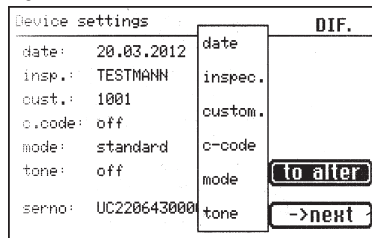
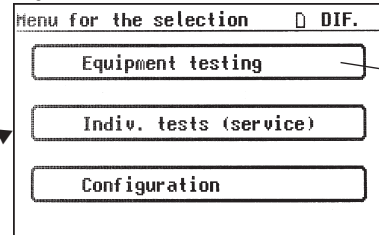

Fig. 66



Entering the appliance identification

Press the [Appliance testing] button in the Main menu (Fig. 66). A screen is displayed requesting entry of the appliance identification. Pressing the [1/A] button changes the display to allow the entry of a test ID number with a maximum of 19 digits (Fig. 67).

This can also be read via a barcode scanner.



Entry of the appliance identification number is not compulsory.

The subsequent entry of the appliance type (Fig. 69) is not compulsory and is automatically displayed for barcode entry. For manual entry you use the [1/A] and [OK] buttons to reach this menu.

Press the [OK] button if you do not wish to enter any information here.

Fig. 67

Appliance testing

ID: _____ 1/A

delete cancel

Fig. 68

Enter appliance identification

ID: 34567

1 2 3 4 5

6 7 8 9 0

C OK ABC

Fig. 69

Enter appliance type

dev.des: PS-24U

ABC DEF GHI JKL MNO

PQRS TUUV WXYZ ., -

C OK 123

Operating manual for the TG uni 1, TG euro 1 and TG euro 1 med appliance tester

Conducting tests in accordance with DIN VDE 0701-0702, Example 3 – Devices with SELV / PELV (PC III)

Test settings

Fig. 71 shows the Main menu for test object protective measures. After selecting the protective measures by pressing the [SELV/PELV (Pc III)] function button you reach the „Settings for measuring“ menu (Fig. 72).

With the function button [hand/auto] you determine whether the test procedure should be carried out manually (by hand) or automatically. The headline (upper right) shows the setting: Manually by hand (m), automatic (a)



Manual test procedure means that you have to confirm every test stage by pressing the [OK] button to get to the next test stage. Automatic test procedure means that a test stage automatically changes to the next after 5 seconds – except for confirmation of connection to the mains voltage (see Point 6.6, basic settings of the appliance tester).

The [cancel] button takes you back to the Main menu. To move to the next stage press the [next] button (also see Diagram 1 in Point 9.8).

Fig. 70

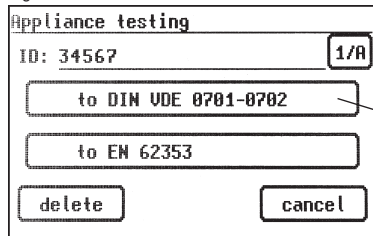

Fig. 71

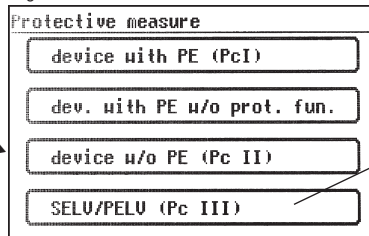
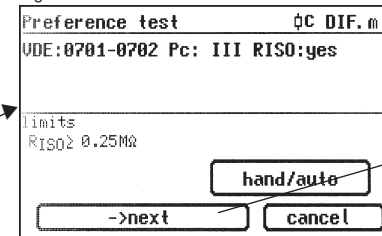



Fig. 72



12.1 Visual inspection

The [next] button takes you to the first stage of the test, the visual inspection (Fig. 73).

The housing, connecting cable, inscriptions and other parts should be inspected in this test. You confirm positive results of the visual inspection by pressing the appropriate buttons – the display changes from „not OK“ to „OK“ (Fig. 74).

 Please note: The visual inspection function is not present when the appliance tester is in „Expert mode“!

 For all subsequent tests, the test object must be switched on.

Pressing the [next] button brings the device to the Insulation resistance test screen (Fig. 76).

12.2 Insulation resistance

The limit value is:
0.25 M Ω (PC III)

After pressing the [next] button, the display for the insulation resistance measurement appears (Fig. 76).

The magnitude of the test voltage is displayed as well as the measured value (minimum of 500 V DC).

 The star sign on the left side of the display blinks when the measuring process is running (the values are being measured). The [OK] button appears when the measured value is determined.

A help display with a measuring principle circuit and a help text is also available available here.

 Since the appliance tester cannot provide the specific low voltage for the test object, a function test is not carried out for test objects in PC III.

Alternatively, the test object can be tested according to PC II with the appropriate power supply unit – see Point 11 on Page 30.

Fig. 73

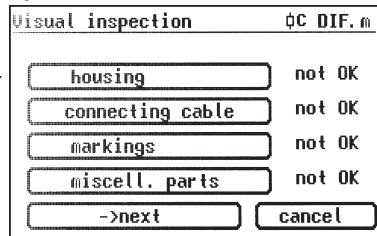

Fig. 74

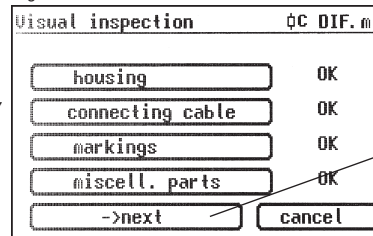
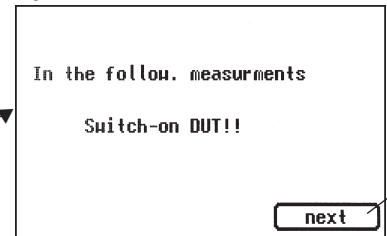

Fig. 75



Operating manual for the TG uni 1, TG euro 1 and TG euro 1 med appliance tester

Conducting tests in accordance with DIN VDE 0701-0702, Example 3 – Devices with SELV / PELV (PC III)

12.3 Documentation

After pressing the [OK] button, the display changes to the „Test result“ screen. Here you can see all the measurement results with the related limit values (Fig. 77).

If the measurement results of the electrical values, the visual inspection and the function test were all in order, the following message appears:

„Test OK“.

If the test was not successful the message says:

„Test not OK!“.

At this point you can cancel the test with the [cancel] button (the display goes back to the „Settings for measuring“ screen) or switch to the „Memory menu“ with the [next] button.

In the „Memory menu“ (Fig. 78) you can confirm or modify the following parameters: device ID number, device designation, name of the inspector, date and customer number.

You can also change the storage location – from internal memory to MMC/SD card and vice-versa. The current setting is displayed via a symbol in the headline of the memory menu.

 The appliance identification can also be read from a barcode label using the optional barcode scanner.

To do this, before starting up the appliance tester connect the plug of the barcode scanner to the RS232 socket of the tester and screw it tight.

You confirm the entries by pressing the [save] button – a „Data were stored“ message is displayed briefly and the display changes to the screen for entering the ID number for the next test.

With the entry of an already used ID number, the data is „attached“ as a new test to this ID number. After saving, the display changes to the screen for entering the ID number – the appliance tester is now ready for another test (Fig. 67).

The test results can be saved on a PC with the supplied PC program or printed from there in the form of a test log. To do this, establish the USB connection between the appliance tester and the PC* (USB cable supplied) or directly copy the saved data from the memory card to the PC using a card reader.

Procedure on the PC – see the operating instructions for the PC software.

* Switch the appliance tester off and on, leave the switch-on message as it is (Fig. 41). Connect the USB cable. The appliance tester is automatically detected by Windows® as removable media. The internal memory is assigned to the first free drive letter and the memory card is assigned to the second free drive letter.

Fig. 76

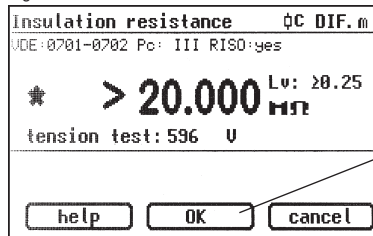

Fig. 77

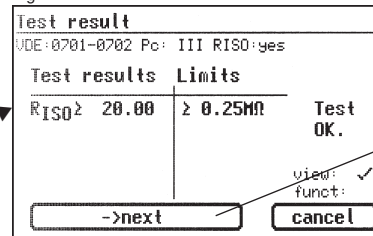
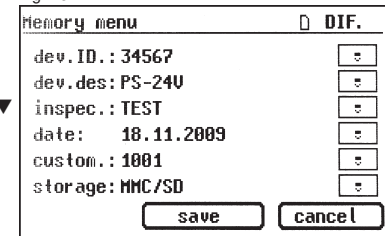









Fig. 78



13. Examples of control codes (at TG euro 1 and TG euro 1 med only)

For a complete list of the control codes see additional sheet!

Control code	Barcode Parameters	Meaning	
PC I			
100	 * 1 0 0 *	RPE < 0.3	RPE, RISO, IEA, with function test
108	 * 1 0 8 *	RPE < 0.3	RPE, RISO (Lv: 0.3 MΩ), IEA (Lv: 1 mA/kW), devices with heating elements >3.5 kW, with function test
124	 * 1 2 4 *	RPE < 0.3	RPE, RISO, protective conductor current, without function test (*)
140	 * 1 4 0 *	RPE < 0.3	RPE, without RISO, with protective conductor current, without function test (*)
156	 * 1 5 6 *	RPE < 0.3	RPE, without RISO, with protective conductor current, with touch current, without function test (*)
PC II			
172	 * 1 7 2 *		RISO, IEA, with function test
173	 * 1 7 3 *		RISO, with touch current, without function test (*)
174	 * 1 7 4 *		Without RISO, with touch current, without function test (*)

* The function test is always performed in expert mode (except for PC III).

**14. Conducting tests with the appliance tester
in accordance with DIN VDE 0701-0702 – Special test procedure
according to customer-specific settings** *(not for DIN-VDE 0751/EN 62353)*

 This input area is locked by a code key (Fig. 81).
Please contact us via email for further information:
info@g-mw.de.

If several tests with identical settings in the appliance tester are to be conducted, then the appliance tester can be „pre-programmed“ for a test series (also see point 6.8).

The following example shows the settings for testing according to DIN VDE 0701-0702 as a periodic inspection, using the differential current measuring method, with protective conductor (PC I), without insulation resistance and with a function test.

The settings are entered in Setup in the Configuration menu, see Figs. 79 to 90.

Fig. 79

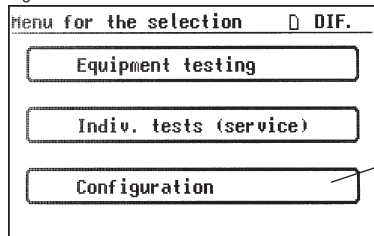

Fig. 80

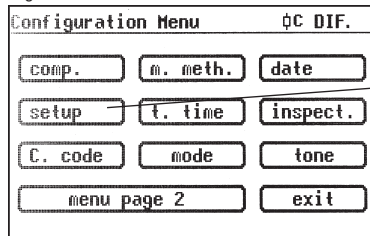

Fig. 81

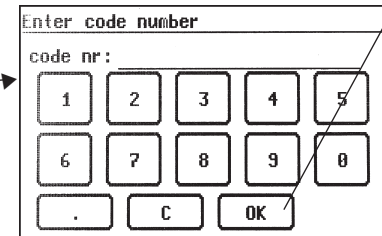

Fig. 82

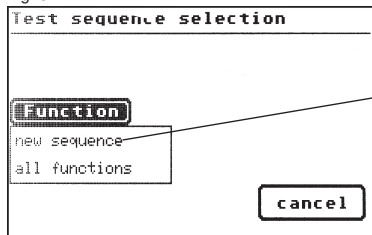

Fig. 83

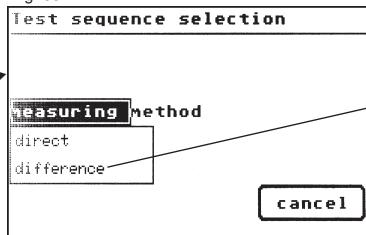

Fig. 84

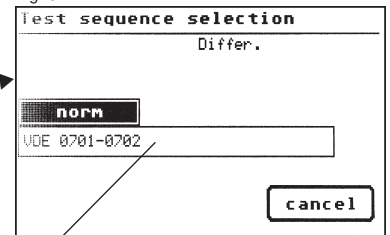

Fig. 85

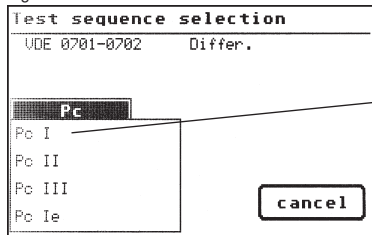

Fig. 86

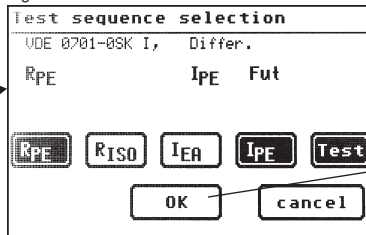
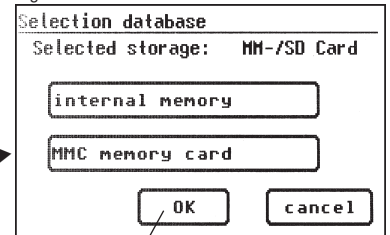

Fig. 87



The appliance tester is now ready to start new tests

Fig. 88

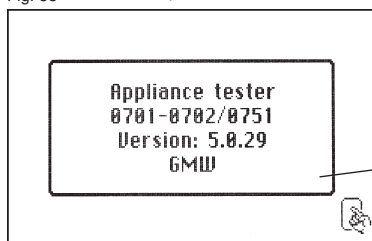

Fig. 89

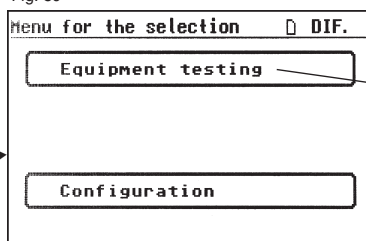
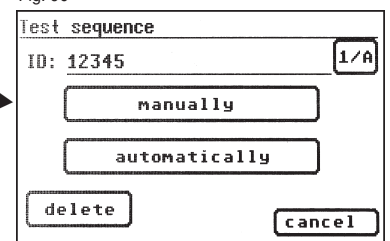

Fig. 90



15. Conducting tests in accordance with DIN VDE 0751-1/EN 62353: Definition of standards

The DIN VDE 0751-1 standard applies to testing of medical electronic devices (ME devices) or medical electronic systems (ME systems) or to parts of such devices or systems that correspond to DIN EN 60601-1 (VDE 0750 Part 1), before commissioning, inspection, maintenance and periodic inspections, in order to assess the safety of such devices or systems or parts of them. For devices which are not constructed according to DIN EN 60601-1 (VDE 0750 Part 1), this standard can be applied analogously with regard to the safety standards applicable for the manufacture of the device.
(from DIN VDE 0751-1: 2001-10, Section 1.1)

15.1 General information

The tests must be performed by qualified personnel. The qualifications must include technical training, knowledge and experience of the applicable standards and local regulations.

Personnel assessing the safety of devices must be able to recognise the possible consequences and dangers resulting from devices that do not meet the specified requirements.

(From DIN VDE 0751-1:2008-08, Section 4.1)

15.2 Sequence of tests

The accompanying documents are to be examined before starting the tests to check for any recommendations the manufacturer may have regarding maintenance, including conditions and precautions.

According to DIN VDE 0751-1 the following sequence of tests is recommended:

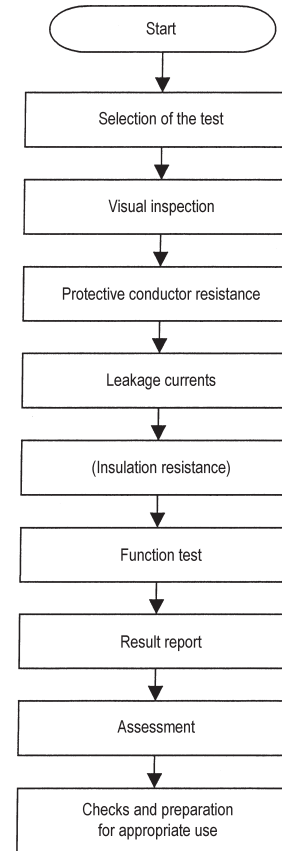

Test sequence according to DIN VDE 0751-1/EN 62353

15.3 Inspection (visual inspection)

Particular attention should be paid to the following:

- that the externally accessible fuse links correspond to the manufacturer's specified values (design value of current, fusing characteristic),
- the safety-relevant markings, labels and inscriptions on the device/ system are legible and complete,
- mechanical parts are undamaged,
- that there is no apparent damage or soiling that could reduce safety,
- that accessories and/or single-use articles used with the device/ system are also assessed (e.g. mains connecting cable, patient connections, tubes),
- the necessary documents are available and reflect the current version of the ME device.

(From DIN VDE 0751-1:2008-08, Section 5.2)

15.4 Protective conductor resistance

The limit value is:

- **0.5 Ω** for ME systems with multi-outlet power strips, between the protective conductor of the mains plug of the multi-outlet power strip and all touchable conductive parts of the ME system mains cable, menu "with power strip"
- **0.3 Ω** for devices with a fixed mains cable (or for devices with removable mains cable on devices with a fixed mains cable), menu „With connection cable“
- **0.2 Ω** for devices with a removable mains cable (between the protective contact of the device plug and the touchable conductive parts), menu „W/o connection cable“
- **0.1 Ω** for the removable mains cable alone, submenu "test cables"

Measuring principle circuit

Protective conductor resistance PC I, Diagram C1

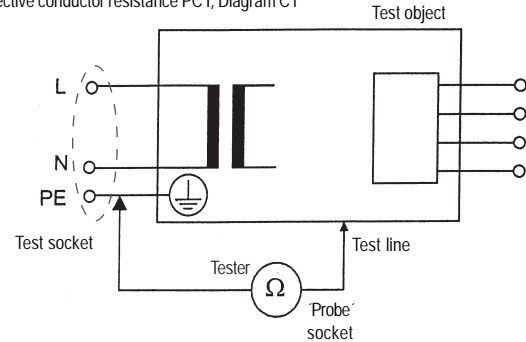

Measuring principle circuit

Protective conductor resistance PC I, Diagram C2

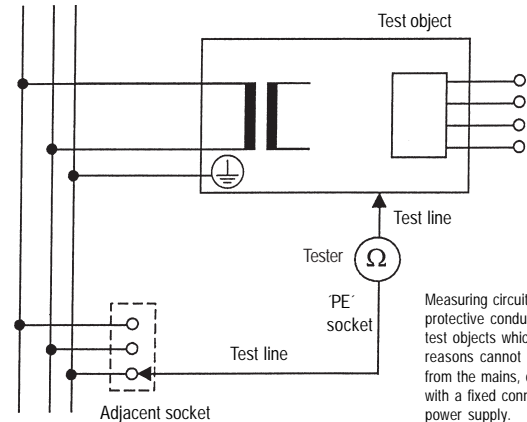

Measuring circuit for measuring the protective conductor resistance of test objects which for operational reasons cannot be disconnected from the mains, or for test objects with a fixed connection to the mains power supply.

Operating manual for the TG uni 1, TG euro 1 and TG euro 1 med appliance tester

Conducting tests in accordance with VDE 0751-1/EN 62353 – Definition of standards

15.5 Leakage currents

Depending on the type of the ME device it may be necessary to measure the device leakage current or the applied part leakage current (previously known as the patient leakage current), the required measurements depend on the equipment used and the classification of the ME device, the manufacturer's specifications must be followed here.

The following measuring methods can be used for this:

- Alternative measurement
- Direct measurement
- Differential current measurement

Leakage currents must not exceed the permissible values listed in Table 1 on Page 49 (see also DIN VDE 0751-1 Table 2).

Measuring setup as an example for measuring the leakage currents (corresponding to the tester), Diagram C3

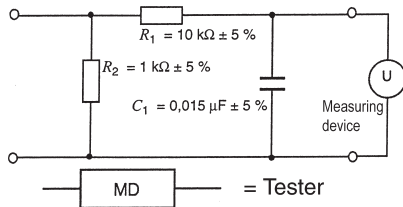

The limit values differ according to the following applied parts (see also Table on Page 49):

B	Applied part B For application and/or body contact (B=body), earthed
BF	Applied part BF For applications and/or body contact (B=body), not earthed (F=floating)
CF	Applied part CF For applications and/or body contact and/or heart contact (C=cardio), not earthed (F=floating).

Table 1 – Permissible limit values for leakage currents

Current μA	APPLIED PART		
	TYPE B	TYPE BF	TYPE CF
DEVICE LEAKAGE CURRENT - Alternative measurement			
– DEVICE LEAKAGE CURRENT FOR TOUCHABLE CONDUCTIVE PARTS OF ME DEVICES OF PROTECTION CLASS I, THAT MAY OR MAY NOT BE CONNECTED TO THE PROTECTIVE CONDUCTOR	1 000	1 000	1 000
– DEVICE LEAKAGE CURRENT FOR ME DEVICES OF PROTECTION CLASS II	500	500	500
DEVICE LEAKAGE CURRENT – DIRECT MEASUREMENT OR DIFFERENTIAL CURRENT MEASUREMENT			
– DEVICE LEAKAGE CURRENT FOR TOUCHABLE CONDUCTIVE PARTS OF ME DEVICES OF PROTECTION CLASS I, THAT MAY OR MAY NOT BE CONNECTED TO THE PROTECTIVE CONDUCTOR	500	500	500
– DEVICE LEAKAGE CURRENT FOR ME DEVICES OF PROTECTION CLASS II	100	100	100
LEAKAGE CURRENT FROM THE APPLIED PART - ALTERNATIVE MEASUREMENT (AC)			
– LEAKAGE CURRENT FROM THE APPLIED PART	–	5 000	50
LEAKAGE CURRENT FROM THE APPLIED PART - DIRECT MEASUREMENT (AC)			
– LEAKAGE CURRENT FROM THE APPLIED PARTS (MAINS VOLTAGE ON APPLIED PART)	–	5 000	50
NOTE 1 This standard does not specify a measuring method or permissible values for devices that generate DC leakage current. In this case the MANUFACTURER should provide specifications in the ACCOMPANYING DOCUMENTS.			
NOTE 2 "Special requirements" may permit other values for the leakage current.			

Table from DIN VDE 0751-1:2008-8

Operating manual for the TG uni 1, TG euro 1 and TG euro 1 med appliance tester
 Conducting tests in accordance with VDE 0751-1/EN 62353 – Definition of standards

Measuring principle circuit for measuring the device leakage current, direct current measurement, Diagram C4

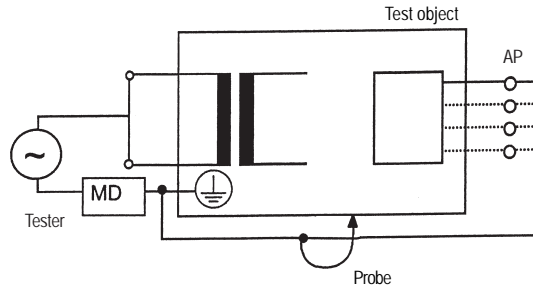

Protection class I

Measuring principle circuit for measuring the device leakage current, alternative measurement, Diagram C5

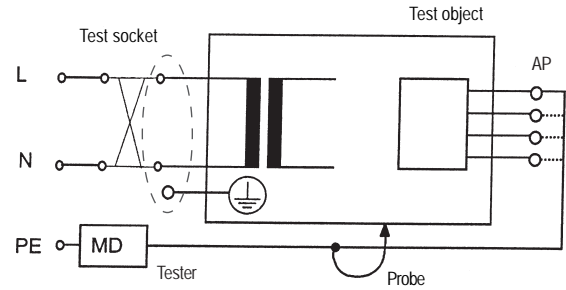

Protection class I

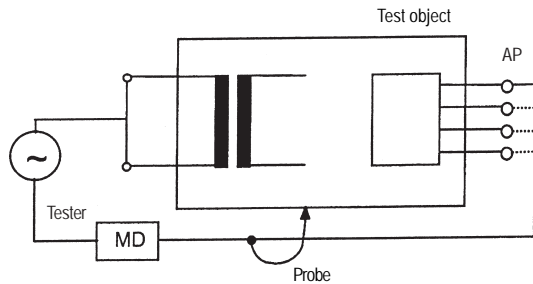

Protection class II

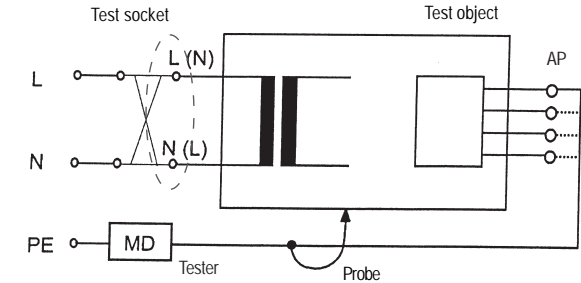

Protection class II

Operating manual for the TG uni 1, TG euro 1 and TG euro 1 med appliance tester
 Conducting tests in accordance with VDE 0751-1/EN 62353 – Definition of standards

Measuring principle circuit for measuring the device leakage current, differential current measurement, Diagram C6

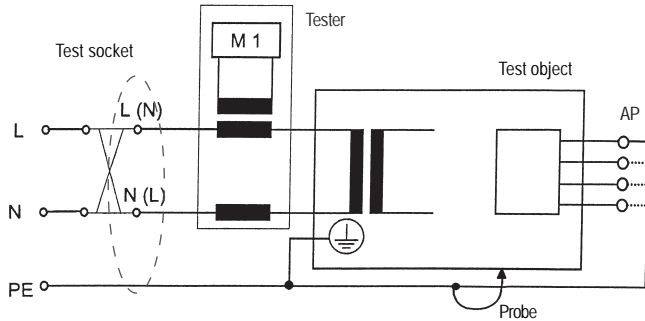

Protection class I

Measuring principle circuit for measuring the device leakage current from the applied part, alternative measurement, Diagram C7

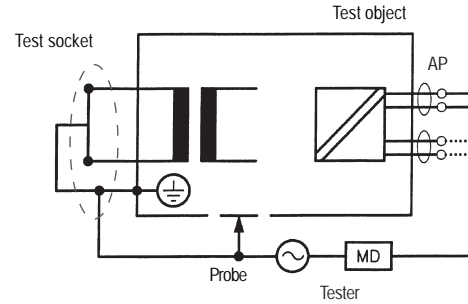

Protection class I

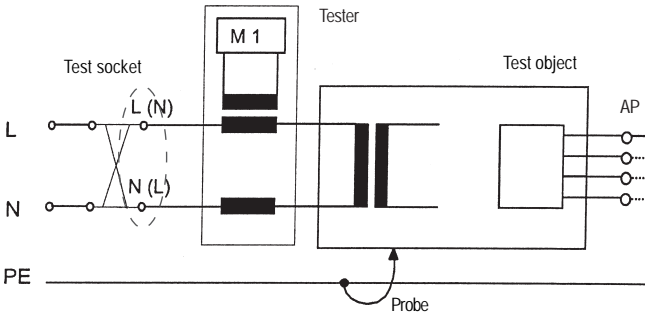

Protection class II

Measuring principle circuit for measuring the leakage current from the applied part, mains voltage on applied part, Diagram C8

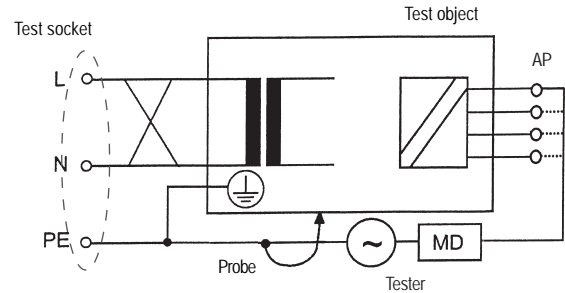

Protection class I

Operating manual for the TG uni 1, TG euro 1 and TG euro 1 med appliance tester

Conducting tests in accordance with VDE 0751-1/EN 62353 – Definition of standards

15.6 Insulation resistance

The current version of DIN VDE 0751-1 states that the insulation resistance must be measured when this is „appropriate“. The insulation resistance must not be measured if the manufacturer's specifications in the accompanying documents explicitly forbid this.

Limit values for insulation resistance are not specified in DIN VDE 0751-1:2008; the manufacturer's specifications or previously measured values can be used for this.

Measuring principle circuit for measuring the insulation resistance between power supply and protective earth (PC I) and between power supply and touchable conductive parts (not earthed, PC II), Diagram C9

PC I

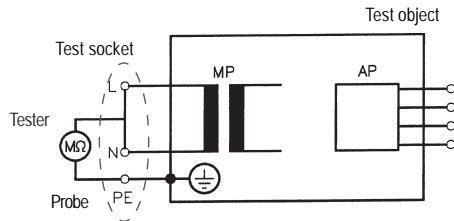

PC II

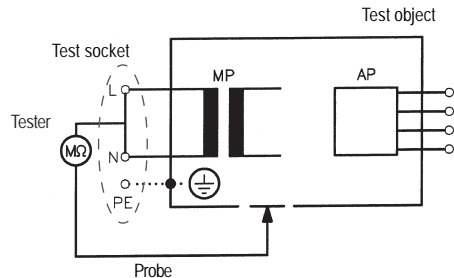

15.7 Function test

All safety-relevant functions must be checked according to the manufacturer's specifications; if necessary the inspector must be supported by a person familiar with the operation of the ME device.

15.8 Assessment

The assessment of the safety of test objects must be performed by electrical professionals having suitable training for the test object. If the safety of the test object is not given, the test object must be appropriately labelled and the operator informed in writing of the potential dangers of the test object.

15.9 Documentation

All tests, measurements, inspections, testing bodies and inspectors must be documented. A final assessment by an electrical professional with appropriate knowledge of the ME device being tested must also be performed.

The documentation must include the following information at least:

- Designation of the testing body (e.g. company, department).
- Name of the inspector and the assessor.
- Designation of the test object and the relevant accessories.
The test documentation must be uniquely assigned to the test object.
- Tests and measurements: date, type, scope and results of the
– visual inspections,
– measurements (measuring method, measuring equipment, measured values),
– function tests.
- Final assessment.
- Date and signature of the assessor.

(DIN VDE 0751-1:2008)

15.10 Diagram 1
Test procedure for ME devices with protection class I

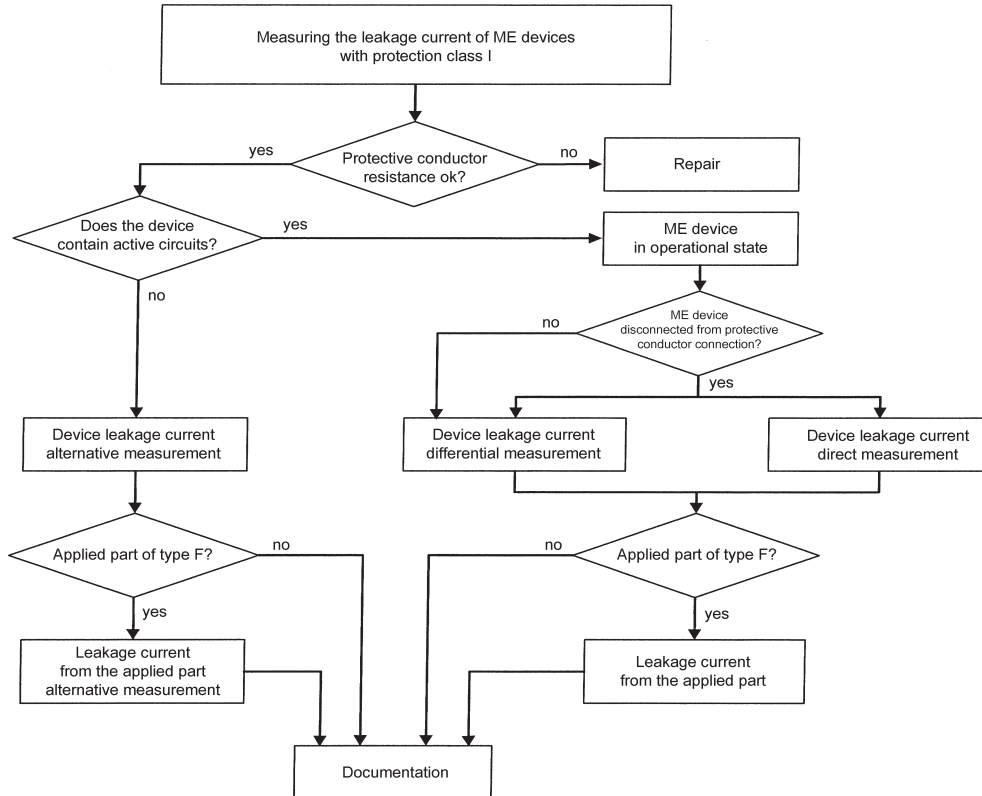

15.11 Diagram 2

Test procedure for ME devices with protection class II

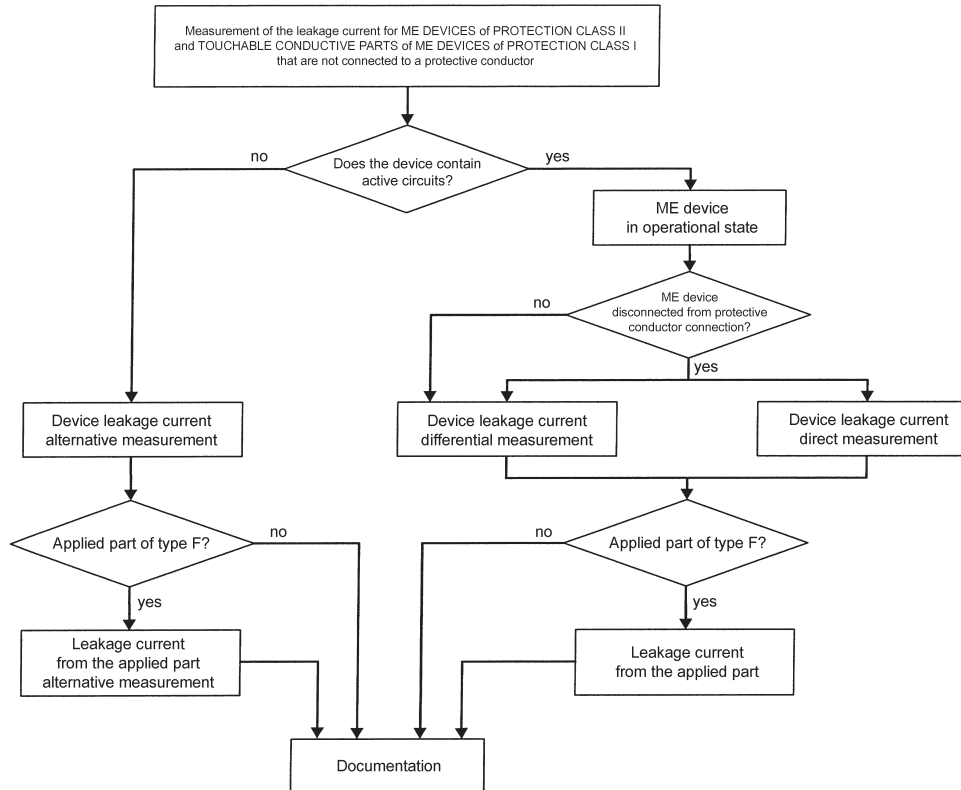

16. Conducting tests with the appliance tester according to DIN VDE 0751-1, Example 4: Devices with protective conductor (PC I) and applied part of type B

 The tests must be performed by qualified personnel. The qualifications must include technical training, knowledge and experience of the applicable standards and local regulations. Personnel assessing the safety of devices must be able to recognise the possible consequences and dangers resulting from devices that do not meet the specified requirements. The testing of the devices must be carried out in compliance with the accompanying documents.

Connecting the test object

- Connect one end of the test line to the probe socket of the appliance tester.
- Use the crocodile clip to connect the other end of the test line with a metal part of the test object, which is connected to the protective conductor.
Ensure that the crocodile clip makes a good contact with the metal part of the test object.
- Connect all applied parts of the test object to the IPEA socket.
- Connect the mains plug of the test object to the test socket of the appliance tester.
- Switch on the test object with the mains switch.

Switching on the appliance tester

Connect the mains plug of the appliance tester to a properly connected and functional earthed mains socket. Switch on the appliance tester via the mains switch. Press the large button in the switch-on display (Fig. 91). The currently set parameters are displayed in the next screen. These can be changed, or simply confirmed using the [next] button (Fig. 92).

 Please note that the device does not have a real time clock. The date must be entered anew or accepted.

Pressing the [next] button brings you to the Main menu (Fig. 93). Here you can also enter the basic settings for the appliance tester via the [Configuration] button (see Page 9 Point 6.1).

Fig. 91

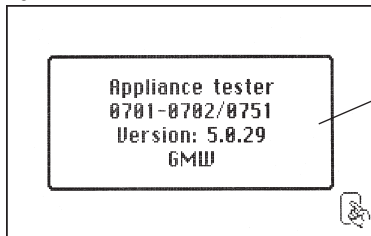

Fig. 92

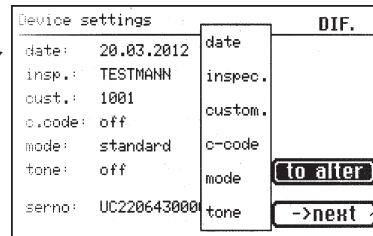
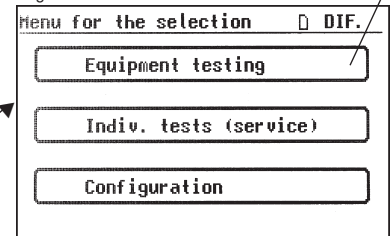

Fig. 93



Operating manual for the TG uni 1, TG euro 1 and TG euro 1 med appliance tester

Conducting tests in accordance with VDE 0751-1/EN 62353, Example 4 - Devices with protective conductor (PC I) and applied part of type B

Entering the appliance identification

Press the [Appliance testing] button in the Main menu (Fig. 93).

A screen is displayed requesting entry of the appliance identification.

Pressing the [1/A] button changes the display to a keypad (Fig. 94) allowing the entry of a test object ID number with a maximum of 19 digits.

You can also read this in using a barcode scanner (Fig. 95).

 Entry of the appliance identification number is not compulsory.

The subsequent entry of the appliance type (Fig. 96) is not compulsory and is automatically displayed for barcode entry. For manual entry you use the [1/A] and [OK] buttons to reach this menu.

Press the [OK] button if you do not wish to enter any information here.

In the Main menu (Fig. 97) press the [to DIN VDE 0751-1] button.

Fig. 94

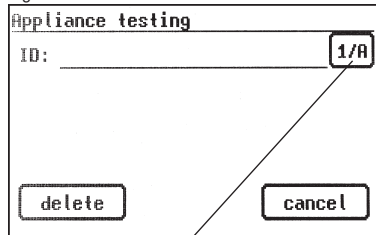

Fig. 95

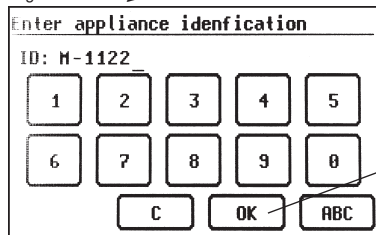

Fig. 96

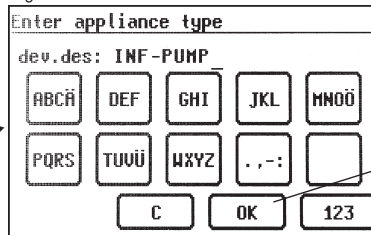
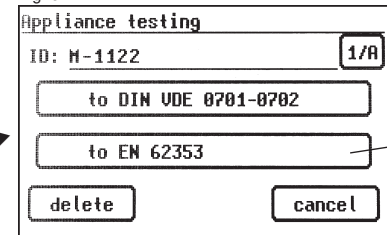

Fig. 97



Test settings

Fig. 98 shows the Main menu for test object protective measures. After selecting the protective measure by pressing the [Devices with PE (Pc I)] button you reach the „Selection parameters“ screen (Fig. 99). Use the [—> RPE (0.3 Ω)] button to set the limit value of the protective conductor resistance (see Fig. 100):

- With connection cable 0.3 Ω
- Without connection cable 0.2 Ω
- With power strip 0.5 Ω

You use the [altern./mains] button to define whether the device leakage current or applied part leakage current (previously known as patient leakage current) is to be measured via alternative measurement or using the mains voltage (direct or differential current).

The [applied part] button is used to switch between Type **B**, **BF** and **CF** applied parts. The test procedure and the limit values for the leakage current are defined according to this setting - see Table 1 on Page 49. Set an applied part of Type **B** here.

Use the [RISO] button to define whether the insulation resistance is to be tested or not. This measurement is deactivated by default and should only be performed after checking the accompanying documents or the manufacturer's specifications.

You use the [auto/hand] function button to define whether the test procedure is performed automatically or manually (by hand). The headline (upper right) shows the setting: Manually by hand (m), automatic (a)

 Manual test procedure means that you have to confirm every test stage by pressing the [OK] button to get to the next test stage. Automatic test procedure means that a test stage automatically changes to the next after 5 seconds – except for confirmation of connection to the mains voltage (see Point 6.6, basic settings of the appliance tester).

The [cancel] button takes you back to the Main menu. To continue – Press the [next] button (Fig. 99).

Fig. 98

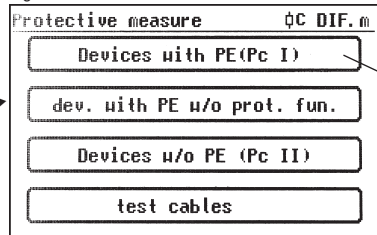

Fig. 99

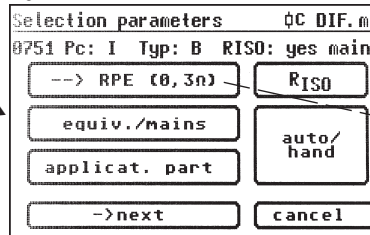
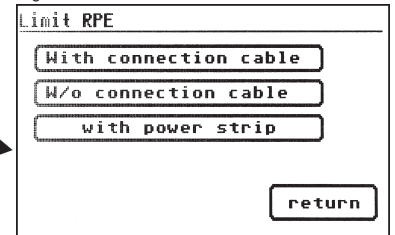

Fig. 100



Operating manual for the TG uni 1, TG euro 1 and TG euro 1 med appliance tester

Conducting tests in accordance with VDE 0751-1/EN 62353, Example 4 - Devices with protective conductor (PC I) and applied part of type B

16.1 Visual inspection

The [next] button takes you to the first stage of the test, the visual inspection (Fig. 101).

The housing, connecting cable, inscriptions and other parts should be inspected in this test. You confirm positive results of the visual inspection by pressing the appropriate buttons – the display changes from „not OK“ to „OK“.

 Please note: The visual inspection screen is not displayed in „Expert mode“

 For all subsequent tests, the test object must be switched on.

Pressing the [next] button displays an operating note and then the device enters the protection conductor resistance test (Fig. 102).

16.2 Protective conductor resistance

The limit value is:

- **0.5 Ω** for ME systems with multi-outlet power strips, between the protective conductor of the mains plug of the multi-outlet power strip and all touchable conductive parts of the ME system mains cable
- **0.3 Ω** for devices with a fixed mains cable (or for devices with removable mains cable on devices with a fixed mains cable)
- **0.2 Ω** for devices with a removable mains cable (between the protective contact of the device plug and the touchable conductive parts)

The [next] button takes you to the first electrical test: the protective conductor resistance (Fig. 103).

The measured value is displayed in large text in the middle of the screen.

 The star sign on the left side of the display blinks when the measuring process is running (the values are being measured). The [OK] button appears when the measured value is determined.

The corresponding limit value „Lv“ and the momentary test current (+) are also displayed.

You can display the help screen by pressing the [help] button. A measuring principle circuit corresponding to the figure in this operating manual and a short help text are displayed. After pressing the [End] button you return to the measuring display.

In the next stage the polarity of the test current (-) is reversed and the protective conductor resistance is measured again.

 During the measurement, the connecting cable of the test object should be moved, section by section, along its whole length, in order to find broken conductors or weak points.

Fig. 101

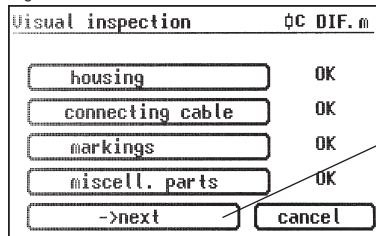

Fig. 102

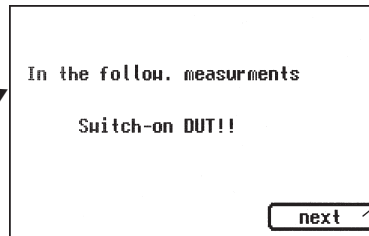
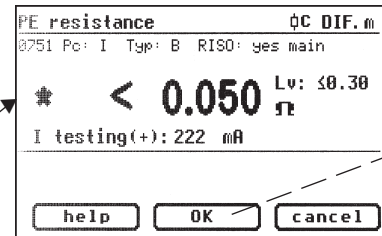

Fig. 103



16.3 Insulation resistance (optional)

If you have selected a test procedure **with insulation resistance** in the parameter selection, the measuring display for the insulation resistance measurement (Fig. 104) appears after you press the [OK] button.

The magnitude of the test voltage is displayed as well as the measured value (minimum of 500 V DC).

16.4 Leakage currents

Limit values – see Table 1 on Page 49.

The limit value of the device leakage current is automatically selected by the appliance tester according to the test settings.



Caution! The test object is supplied with mains voltage during the test.

When measuring the device leakage current (direct measurement) the protective conductor connection of the test object is opened in order to test under the conditions of the first fault.

(According to DIN VDE 0751-1 Section 5.3.3.1)

In this measurement the special 1 kΩ resistor is connected between the mains protective conductor and the protective conductor connection of the test object.



Do not touch the test object during the test!

It is also recommended that you take additional protective measures, e.g. operate the test object using a residual current detector (RCD).

Fig. 104

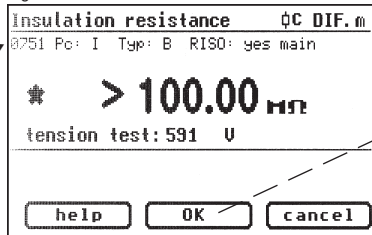

Fig. 105

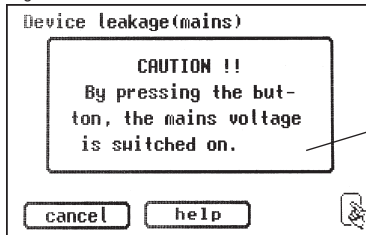
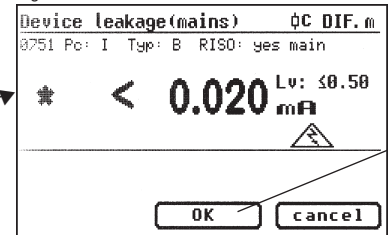

Fig. 106



The next screen (Fig. 105) displays a warning before the mains voltage is switched on.

With your assent – by pressing the large button – the display changes to measuring the device leakage current and the mains voltage is connected again.

You can see the measured value in the middle of the display, with the related limit value to the right (Fig. 106).



The star sign on the left side of the display blinks when the measuring process is running (the values are being measured). The [OK] button appears when the measured value is determined.

The symbol blinks to indicate the connection to the mains voltage.

With the [help] button, you can also go to a help display from here.

Pressing the [OK] button automatically **reverses the polarity** of the mains plug of the test object.

Thereafter, you are again warned about the connection to the mains voltage. After confirmation by pressing the large button, the mains voltage is switched on again and the device leakage current is measured again.



To select the measuring method for device leakage current: direct or differential current – see point 6.3 „Setting the measuring method - Protective conductor current measurement“.

Operating manual for the TG uni 1, TG euro 1 and TG euro 1 med appliance tester

Conducting tests in accordance with VDE 0751-1/EN 62353, Example 4 - Devices with protective conductor (PC I) and applied part of type B

16.5 Function test

Press the [OK] button to go to the „Function test“ menu.



Caution! The test object is supplied with mains voltage during the test.

Before the mains voltage is connected a warning message may appear in the display. The automatic test procedure is stopped; it only proceeds when a button is pressed (Fig. 107).

After you have confirmed execution of the function test by pressing the button, the appliance tester changes over to the function test display (Fig. 108).

The display shows the instantaneous mains voltage, the load current, the active power, apparent power and reactive power, the power factor and mains frequency.

16.6 Inspecting the inscriptions

At this point the values displayed in the function test should be compared with the data on the type plate of the test object.

Fig. 107

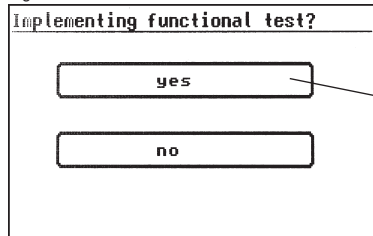

Fig. 108

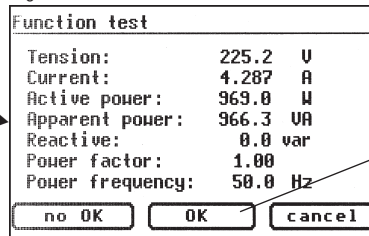
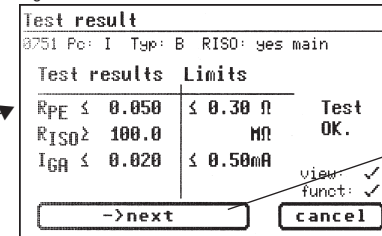

Fig. 109



16.7 Documentation

After pressing the [OK] button, the display changes to the „Test result“ screen (Fig. 109).

Here you can see all the measurement results with the related limit values.

If the measurement results of the electrical values, the visual inspection and the function test were all in order, the following message appears:

„Test OK“.

If the test was not successful the message says:

„Test not OK!“.

At this point you can cancel the test with the [cancel] button (the display goes back to the „Appliance testing“ screen) or switch to the „Memory menu“ with the [next] button.

In the „Memory menu“ (Fig. 110) you can confirm or modify the following parameters: device ID number, device designation, name of the inspector, date and customer number.

You can also change the storage location – from internal memory to MMC/SD card and vice-versa.

The current setting is displayed via a symbol in the headline of the memory menu.

 The appliance identification can also be read from a barcode label using the optional barcode scanner. To do this, before starting up the appliance tester connect the plug of the barcode scanner to the RS232 socket of the tester and screw it tight.

The test results can be saved on a PC with the supplied PC program or printed from there in the form of a test log. To do this, establish the USB connection between the appliance tester and the PC* (USB cable supplied) or directly copy the saved data from the memory card to the PC using a card reader.

Procedure on the PC – see the operating instructions for the PC software.

* Switch the appliance tester off and on, leave the switch-on message as it is (Fig. 41). Connect the USB cable. The appliance tester is automatically detected by Windows® as removable media. The internal memory is assigned to the first free drive letter and the memory card is assigned to the second free drive letter.

Symbols for memory settings:



-  – Internal memory
-  – MMC/SD memory card

Fig. 110

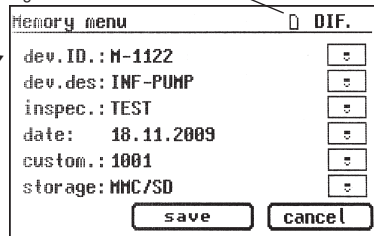

Fig. 111

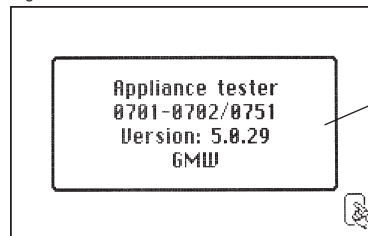
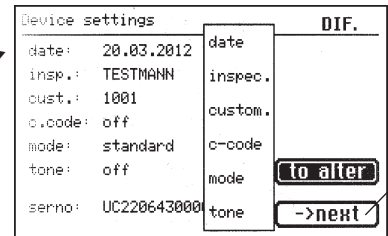



Fig. 112



17. Conducting tests with the appliance tester according to DIN VDE 0751-1, Example 5: Devices without protective conductor (PC II) and with applied parts of Type CF (or BF)

 The tests must be performed by qualified personnel. The qualifications must include technical training, knowledge and experience of the applicable standards and local regulations. Personnel assessing the safety of devices must be able to recognise the possible consequences and dangers resulting from devices that do not meet the specified requirements. The testing of the devices must be carried out in compliance with the accompanying documents.

Connecting the test object

- Connect one end of the test line to the probe socket of the appliance tester.
- Use the crocodile clip to connect the other end of the test line with a metal part of the test object, which is connected to the protective conductor. Ensure that the crocodile clip makes a good contact with the metal part of the test object.
- Connect all applied parts of the test object to the IPEA socket.
- Connect the mains plug of the test object to the test socket of the appliance tester.
- Switch on the test object with the mains switch.

Operating manual for the TG uni 1, TG euro 1 and TG euro 1 med appliance tester

Conducting tests in accordance with VDE 0751-1/EN 62353, Example 5 - Devices without protective conductor (PC II) and with applied part of type CF (or BF)

Switching on the appliance tester

Connect the mains plug of the appliance tester to a properly connected and functional earthed mains socket. Switch on the appliance tester via the mains switch. Press the large button in the switch-on display (Fig. 111). The currently set parameters are displayed in the next screen. These can be changed, or simply confirmed using the [next] button (Fig. 112).

 Please note that the device does not have a real time clock. The date must be entered anew or accepted.

Pressing the [next] button brings you to the Main menu (Fig. 113). Here you can also enter the basic settings for the appliance tester via the [Configuration] button (see Page 9 Point 6.1).

Entering the appliance identification

Press the [Appliance testing] button in the Main menu (Fig. 113). A screen is displayed requesting entry of the appliance identification. Pressing the [1/A] button changes the display to a keypad (Fig. 114) allowing the entry of a test object ID number with a maximum of 19 digits (Fig. 115). This can also be read via a barcode scanner.

 Entry of the appliance identification number is not compulsory.

The subsequent entry of the appliance type is not compulsory and is automatically displayed for barcode entry. For manual entry you use the [1/A] and [OK] buttons to reach this menu.

Press the [OK] button if you do not wish to enter any information here.

In the Main menu (Fig. 116) press the [to DIN VDE 0751-1] button.

Fig. 113

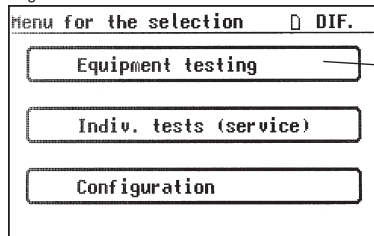

Fig. 114

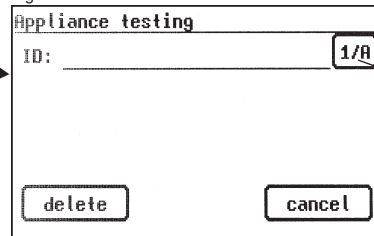
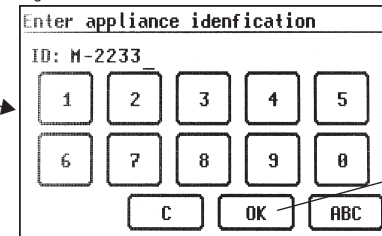

Fig. 115



Test settings

Fig. 117 shows the Main menu for test object protective measures.

After selecting the protective measure by pressing the [Devices with PE (PC II)] button you reach the „Selection parameters 0751-1“ screen (Fig. 118).

You use the [altern./mains] button to define whether the device leakage current or applied part leakage current (previously known as patient leakage current) is to be measured via alternative measurement or using the mains voltage (direct or differential current).

The [applied part] button is used to switch between Type **B**, **BF** and **CF** applied parts. The test procedure is determined and the limit values for the leakage current are specified according to these settings – see Table 1 on Page 49.

Set an applied part of (e.g.) Type CF here.

Use the [RISO] button to define whether the insulation resistance is to be tested or not.

You use the [auto/hand] function button to define whether the test procedure is performed automatically or manually (by hand).

The headline (upper right) shows the setting:

Manually by hand (m), automatic (a)

 Manual test procedure means that you have to confirm every test stage by pressing the [OK] button to get to the next test stage.

Automatic test procedure means that a test stage automatically changes to the next after 5 seconds – except for confirmation of connection to the mains voltage (see Point 6.6, basic settings of the appliance tester).

The [cancel] button takes you back to the Main menu. To continue – Press the [next] button.

Fig. 116

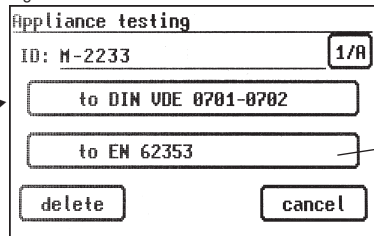

Fig. 117

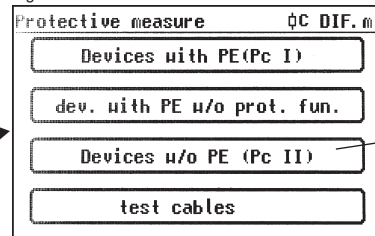
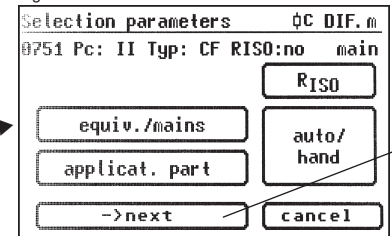

Fig. 118



Operating manual for the TG uni 1, TG euro 1 and TG euro 1 med appliance tester

Conducting tests in accordance with VDE 0751-1/EN 62353, Example 5 - Devices without protective conductor (PC II) and with applied part of type CF (or BF)

17.1 Visual inspection

The [next] button takes you to the first stage of the test, the visual inspection (Fig. 119).

The housing, connecting cable, inscriptions and other parts should be inspected in this test. You confirm positive results of the visual inspection by pressing the appropriate buttons – the display changes from „not OK“ to „OK“.

-  Please note: The visual inspection screen is not displayed in „Expert mode“
For all subsequent tests, the test object must be switched on.

Pressing the [next] button brings the device to the leakage current test screen (Fig. 121).

17.2 Leakage currents

Limit values – see Table 1 on Page 49

If a test procedure for measuring device leakage currents is selected from the [Selection parameters] menu (Fig. 118), then the appliance tester enters the menu for measuring the device leakage current.

The limit value of the device leakage current is set automatically.

-  **Caution! The test object is supplied with mains voltage during the test.**

Fig. 119

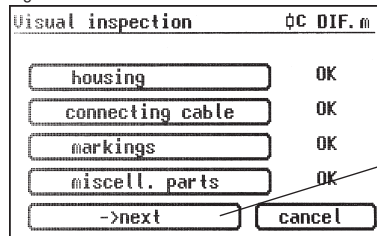

Fig. 120

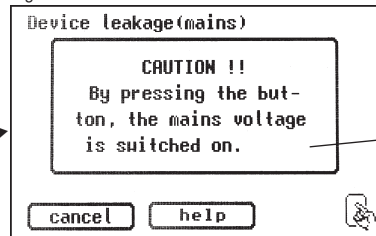
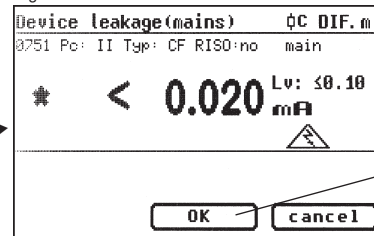



Fig. 121



The next screen (Fig. 120) displays a warning before the mains voltage is switched on.

With your assent – by pressing the large button – the display changes to measuring the device leakage current and the mains voltage is connected again.

You can see the measured value in the middle of the display, with the related limit value to the right (Fig. 121).

-  The star sign on the left side of the display blinks when the measuring process is running (the values are being measured).
The [OK] button appears when the measured value is determined.

The symbol  blinks to indicate the connection to the mains voltage.

With the [help] button, you can also go to a help display from here. Pressing the [OK] button automatically **reverses the polarity** of the mains plug of the test object.

Thereafter, you are again warned about the connection to the mains voltage. After confirmation by pressing the large button, the mains voltage is switched on again and the device leakage current is measured again.

-  To select the measuring method for device leakage current: direct or differential current – see point 6.3 „Setting the measuring method – Protective conductor current measurement“.

17.3 Leakage current from the applied part

Limit values – see Table 1 on Page 49

Here the current flowing from the power supplies and touchable conductive parts to the applied parts is measured (Fig. 122).

With the „altern.“ setting the leakage current is determined using the alternative measuring method (previously designated as substitute patient leakage current).

With the „mains“ setting the leakage current is determined by applying an auxiliary voltage between the mains protective conductor (and housing parts) and the applied part (previously designated as patient leakage current - mains voltage at the applied part).

 The star sign on the left side of the display blinks when the measuring process is running (the values are being measured). The [OK] button appears when the measured value is determined.

The symbol & blinks to indicate the connection to the mains voltage.

With the [help] button, you can also go to a help display from here.

Pressing the [OK] button automatically **reverses the polarity** of the mains plug of the test object.

Fig. 122

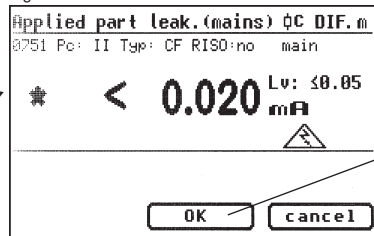

Fig. 123

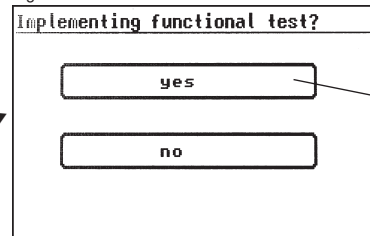
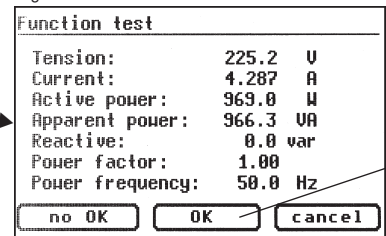



Fig. 124



Thereafter, you are again warned about the connection to the mains voltage. After confirmation by pressing the large button, the mains voltage is switched on again and the leakage current of the applied part is measured again.

17.4 Function test

Press the [OK] button to go to the „Function test“ menu.

 **Caution! The test object is supplied with mains voltage during the test.**

Before the mains voltage is connected a warning message may appear in the display. The automatic test procedure is stopped; it only proceeds when a button is pressed (Fig. 123).

After you have confirmed execution of the function test by pressing the button, the appliance tester changes over to the function test display (Fig. 124).

The display shows the instantaneous mains voltage, the load current, the active power, apparent power and reactive power, the power factor and mains frequency.

17.5 Inspecting the inscriptions

At this point the values displayed in the function test should be compared with the data on the type plate of the test object.

Operating manual for the TG uni 1, TG euro 1 and TG euro 1 med appliance tester

Conducting tests in accordance with VDE 0751-1/EN 62353, Example 6 - Testing removable cables

17.6 Documentation

After pressing the [OK] button, the display changes to the „Test result“ screen (Fig. 125).

Here you can see all the measurement results with the related limit values.

If the measurement results of the electrical values, the visual inspection and the function test were all in order, the following message appears:

„Test OK“.

If the test was not successful the message says:

„Test not OK!“.

At this point you can cancel the test with the [cancel] button (the display goes back to the „Appliance testing“ screen) or switch to the „Memory menu“ with the [next] button.

In the „Memory menu“ (Fig. 126) you can confirm or modify the following parameters: device ID number, device designation, name of the inspector, date and customer number.

You can also change the storage location – from internal memory to MMC/SD card and vice-versa.

The current setting is displayed via a symbol in the headline of the memory menu.

Fig. 125

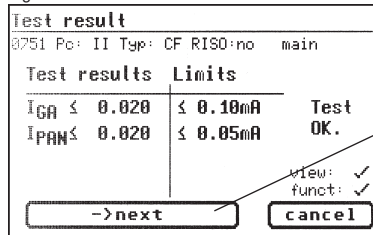
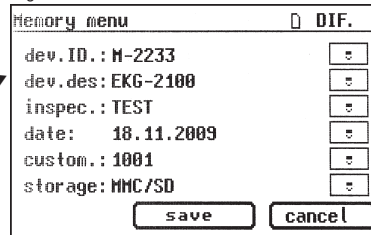



Fig. 126



18. Conducting tests with the appliance tester according to DIN VDE 0751-1/EN 62353, Example 6: Testing removable cables

 The tests must be performed by qualified personnel. The qualifications must include technical training, knowledge and experience of the applicable standards and local regulations. Personnel assessing the safety of devices must be able to recognise the possible consequences and dangers resulting from devices that do not meet the specified requirements. The testing of the devices must be carried out in compliance with the accompanying documents.

Connecting the test object

- Connect one end of the test line to the probe socket of the appliance tester.
- Use the crocodile clip to connect the other end of the test line with the end of the protective conductor of the cable to be tested. Ensure that the crocodile clip makes a good contact with the protective conductor.
- Connect the mains plug of the cable to be tested to the test socket of the appliance tester.

Fig. 127

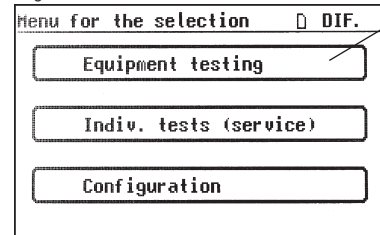

Switching on the appliance tester

Connect the mains plug of the appliance tester to a properly connected and functional earthed mains socket. Switch on the appliance tester via the mains switch. Press the large button in the switch-on display (Fig. 111). The currently set parameters are displayed in the next screen. These can be changed, or simply confirmed using the [next] button (Fig. 112).

 Please note that the device does not have a real time clock. The date must be entered anew or accepted.

Pressing the [next] button brings you to the Main menu (Fig. 127). Here you can also enter the basic settings for the appliance tester via the [Configuration] button (see Page 9 Point 6.1).

Fig. 128

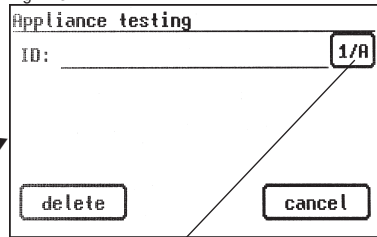

Fig. 129

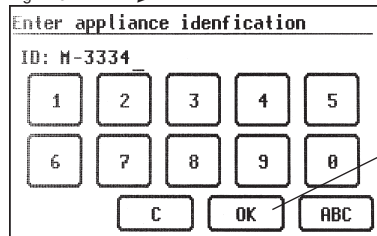

Fig. 130

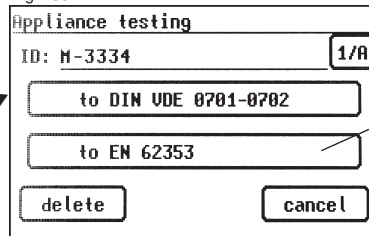
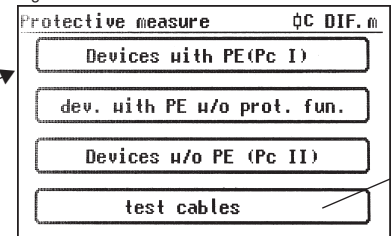



Fig. 131



Entering the appliance identification

Press the [Appliance testing] button in the Main menu (Fig. 127). A screen is displayed requesting entry of the appliance identification. Pressing the [1/A] button changes the display to a keypad (Fig. 128) allowing the entry of a test object ID number with a maximum of 19 digits. This can also be read via a barcode scanner.

 Entry of the appliance identification number is not compulsory.

The subsequent entry of the appliance type is not compulsory and is automatically displayed for barcode entry. For manual entry you use the [1/A] and [OK] buttons to reach this menu.

Press the [OK] button if you do not wish to enter any information here.

In the Main menu (Fig. 130) press the [to DIN VDE 0751-1] button.

Operating manual for the TG uni 1, TG euro 1 and TG euro 1 med appliance tester

Conducting tests in accordance with VDE 0751-1, Example 6 - Testing removable cables

Test settings

Fig. 131 shows the Main menu for test object protective measures.

After selecting the protective measures [test cables] you reach the „Settings for measuring“ menu (Fig. 132).

The limit value for the protective conductor resistance is automatically set to **0.1 Ω** here by the appliance tester.

You use the [auto/hand] function button to define whether the test procedure is performed automatically or manually (by hand).

The headline (upper right) shows the setting:

Manually by hand (m), automatic (a)

 Manual test procedure means that you have to confirm every test stage by pressing the [OK] button to get to the next test stage.

Automatic test procedure means that a test stage automatically changes to the next after 5 seconds – except for confirmation of connection to the mains voltage (see Point 6.6, basic settings of the appliance tester).

The [cancel] button takes you back to the Main menu. To continue – Press the [next] button.

Fig. 132

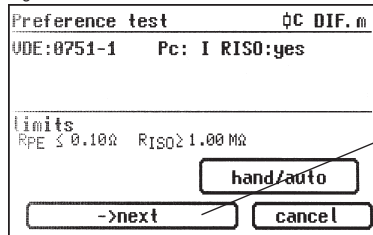
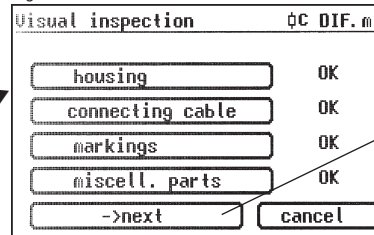



Fig. 133



18.1 Visual inspection

The [next] button takes you to the first stage of the test, the visual inspection (Fig. 133).

This test is a visual inspection of the connecting cables, inscriptions and other parts. You confirm positive results of the visual inspection by pressing the appropriate buttons – the display changes from „not OK“ to „OK“.

 Please note: The visual inspection screen is not displayed in „Expert mode“

For all subsequent tests, the test object must be switched on.

18.2 Protective conductor resistance

The limit value is:

– **0.1 Ω** for the removable mains connecting cable alone

The [next] button takes you to the first electrical test: the protective conductor resistance (Fig. 134).

The measured value is displayed in large text in the middle of the screen.



 The star sign on the left side of the display blinks when the measuring process is running (the values are being measured). The [OK] button appears when the measured value is determined.

Fig. 134

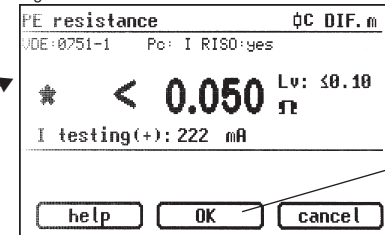

You can display the help screen by pressing the [help] button. A measuring principle circuit corresponding to the figure in this operating manual and a short help text are displayed. After pressing the [End] button you return to the measuring display.

In the next stage the polarity of the test current (-) is reversed and the protective conductor resistance is measured again.

 During the measurement, the connecting cable should be moved, section by section, along its whole length, in order to find broken conductors or weak points.

The corresponding limit value „Lv“ and the momentary test current (+) are also displayed.

18.3 Insulation resistance

After pressing the [OK] button the screen for insulation resistance measurements is displayed (Fig. 135). The magnitude of the test voltage is displayed as well as the measured value (minimum of 500 V DC).

 The star sign on the left side of the display blinks when the measuring process is running (the values are being measured). The [OK] button appears when the measured value is determined.

A help display with a measuring principle circuit and a help text is also available available here.

Fig. 135

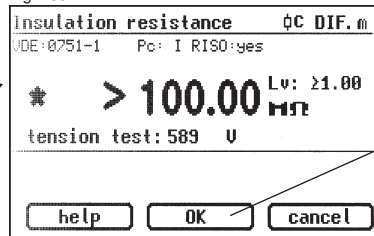

Fig. 136

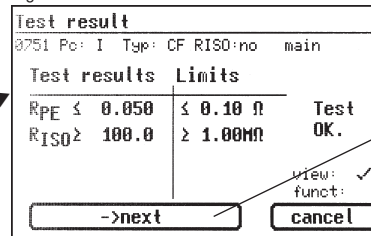
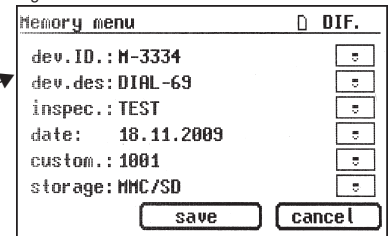

Fig. 137



18.4 Documentation

After pressing the [OK] button, the display changes to the „Test result“ screen (Fig. 136).

Here you can see all the measurement results with the related limit values.

If the electrical values of all the measured results were ok, and the visual inspection was also ok, then a message is displayed:

„Test OK“.

If the test was not successful the message says:

„Test not OK!“.

At this point you can cancel the test with the [cancel] button (the display goes back to the „Appliance testing“ screen) or switch to the „Memory menu“ with the [next] button.

In the „Memory menu“ (Fig. 137) you can confirm or modify the following parameters: device ID number, device designation, name of the inspector, date and customer number.

You can also change the storage location – from internal memory to MMC/SD card and vice-versa.

The current setting is displayed via a symbol in the headline of the memory menu.

Operating manual for the TG uni 1, TG euro 1 and TG euro 1 med appliance tester

Technical data

19. Technical data

Protective conductor resistance:

Measurement range	0.1 – 2.000 Ω
Display range	0.05 – 2 Ω
Resolution	0.001 Ω
Tolerance	\pm (5 % + 0.05 Ω)
Measurement current/voltage	min. 200 mA DC (+/-) / >4 V

Insulation resistance:

Measurement range	0.1 – 100 M Ω
Display range	0.1 – 100 M Ω
Resolution	0.001 M Ω
Tolerance	\pm (5 % + 0.02 M Ω)
Measurement voltage/current	min. 500 V DC / >1 mA

Substitute leakage current:

Measurement range	0.25 – 20 mA
Display range	0.25 – 20 mA
Resolution	0.001 mA
Tolerance	\pm (5 % + 0.05 mA)
Measurement voltage/current	approx. 230 V AC / < 3.5 mA

Protective conductor current, direct:

Measurement range	0.25 – 20 mA
Display range	0.25 – 20 mA
Resolution	0.001 mA
Tolerance	\pm (5 % + 0.05 mA)

Touch current, direct:

Measurement range	0.1 – 2 mA
Display range	0.1 – 2 mA
Resolution	0.001 mA
Tolerance	\pm (5 % + 0.005 mA)

Protective conductor current, differential current:

Measurement range	0.25 – 20 mA
Display range	0.25 – 20 mA
Resolution	0.001 mA
Tolerance	\pm (5 % + 0.05 mA)

Touch current, differential current:

Measurement range	0.1 – 2 mA
Display range	0.1 – 2 mA
Resolution	0.001 mA
Tolerance	\pm (5 % + 0.005 mA)

Device leakage current, applied part leakage current (alternative measurement):

Measurement range	0.02 – 15 mA
Display range	0.02 – 15 mA
Resolution	0.001 mA
Tolerance	\pm (5 % + 0.005 mA)
Measurement voltage/current	approx. 230 V AC / < 3.5 mA

Device leakage current (direct measurement, differential current measurement):

Measurement range	0.02 – 9 mA
Display range	0.02 – 10 mA
Resolution	0.001 mA
Tolerance	\pm (5 % + 0.005 mA)

Leakage current from the applied part, mains voltage at the applied part:

Measurement range	0.02 – 15 mA
Display range	0.02 – 15 mA
Resolution	0.001 mA
Tolerance	Range 0.02 – 0.5 mA: \pm (7.5 % + 0.007 mA)* Range > 0.5 – 15 mA: \pm 5 %*
Measurement voltage/current	approx. 230 V AC / < 3.5 mA
Measurement principle	Alternative measurement

* Note: Additional deviations may be caused by faults in the protective conductor

19.1 Technical data for function test

Voltage:

Measurement range	195.0 – 250.0 V AC
Display range	190 – 250 V
Resolution	0.1 V
Tolerance	± 2.5 %

Current:

Measurement range	0 – 16.00 A
Display range	0 – 16 A
Resolution	0.001 A
Tolerance	± 6 %

Active power:

Measurement range	0 – 3700 W
Display range	0 – 3700 W
Resolution	0.1 W
Tolerance	± 9 %

Reactive power:

Measurement range	0 – 3700 var
Display range	0 – 3700 var
Resolution	0.1 var
Tolerance	± 9 %

Apparent power:

Measurement range	0 – 3700 VA
Display range	0 – 3700 VA
Resolution	0.1 VA
Tolerance	± 9 %

Power factor:

Measurement range	0 – 1
Display range	0 cap. – 1 – 0 ind.
Resolution	0.01
Tolerance	± 3 %

Frequency:

Measurement range	40.0 – 50.0 – 60.0 Hz
Display range	40 – 50 – 60 Hz
Resolution	0.1 Hz
Tolerance	± 3 %

19.2 General technical data

Internal memory capacity	16 MB
MMC/SD memory card capacity	128 MB / 1 GB
Serial interface	9600 baud, no parity, 1 stop bit
USB connection	USB 1.1
Power supply	230 V AC, 50 Hz, (+10 % -15 %)
Operating consumption	approx. 10 VA
Degree of pollution	2
Overvoltage category	CAT II 300 V
Protection degree	IP 40
Protection class	I
Electrical safety	according to EN61010-1 / VDE 0411 according to DIN VDE 0404 Parts 1, 2, 3 according to DIN VDE 0413 Parts 1, 2, 4
EMC emission	according to EN 55011
EMC interference resistance	according to EN 61000-4-2
Dimensions	approx. 300 x 250 x 130 mm (W x D x H), approx. 360 x 285 x 175 mm (W x D x H) for A-Version
Weight	approx. 3.1 kg (incl. accessories), approx. 4.2 kg (incl. accessories) for A-Version

Optional barcode scanner with serial interface (9-pin Sub-D) and internal power supply via pin 9.

19.3 Calibrating the appliance tester

According to the DIN VDE 0701-0702:2008-06 standard:

„Measuring devices used for testing must be regularly checked and calibrated.“

We recommend a calibration interval of one year. Shorter periods are recommended if the device is frequently used or used under tough conditions. If the device is seldom used then the calibration interval can be extended up to a maximum of 3 years.

20. Note on using the internal memory or external memory (MMC/SD card) of the appliance tester

The MMC/SD memory card can be read as described, deleted and formatted with File Manager from the Windows® - Surface. Using the included USB cable to connect the device tester with the PC on which to automatically create a new Removable Disk Drive reports. You can also use the, possibly on the PC available, card reader. The contents of internal memory, only by copying the data to the memory card can be edited (page 12, Figure 12).

The following points should be observed when working with the memories:

- When storing data during a measurement the „TG-MMC.DAT“ file is automatically created. If the file already exists the subsequent data records are attached to the existing data.
- If files in the memory are changed by means of the file manager, only short filenames and file types may be used (filename: 8 characters, file type: 3 characters).
- **WARNING! Failure to observe this restriction will destroy all existing data on the media!!!**
- If a file on the removable media (MMC/SD card) is renamed, only the file type must be changed (e.g. „TG-MMC.DAT“ to “TG-MMC.001”).
- Multiple files with a „DAT“ file type may not exist on the media.

The above points refer only to work with the existing memories in the appliance tester. If you copy the file to a PC hard disk you may also use long filenames and process them using the supplied „TGUNI1PROT.EXE“ PC program.

The **[delete] button** in the configuration menu (page 2) is available for deleting the media. You can change the selected memory via the **[memory] button**.

You can also erase the memory using the PC file manager.

21. Manufacturer's guarantee conditions

The TG uni 1 med appliance tester is subject to a strict quality inspection. Nevertheless, we grant a 24 month manufacturer's guarantee in the case of malfunctions during normal daily usage.

Manufacturing or material faults will be remedied, free of charge, as long as the device shows no signs of third party actions and is unopened before it is sent back to us.

Damage resulting from the device being dropped or mishandled is excluded from guarantee claims.



Gilgen, Mueller & Weigert Nuremberg (GMW)
Zweigniederlassung der General Elektronik GmbH
Am Farrnbach 4A • D-90556 Cadolzburg
Telefon +49 (0)9103 7129-0
Telefax +49 (0)9103 7129-205/207
E-mail: info@g-mw.de • Internet: www.g-mw.de

