

ASK 41.6 Plug-in current transformer

Plug-in current transformer for primary nominal currents from 50 A up to 1000 A, secondary nominal current 5 A or 1 A (optional 2 A), accuracy class 0.5 and 1 (optional in class 0.2 and 0.5s).



Dimensions:

Bus bar 1: 40 x 12 mm
Bus bar 2: 30 x 15 mm
Round conductor: 32 mm
Width: 95 mm
Height: 116 mm
Depth: 74 mm

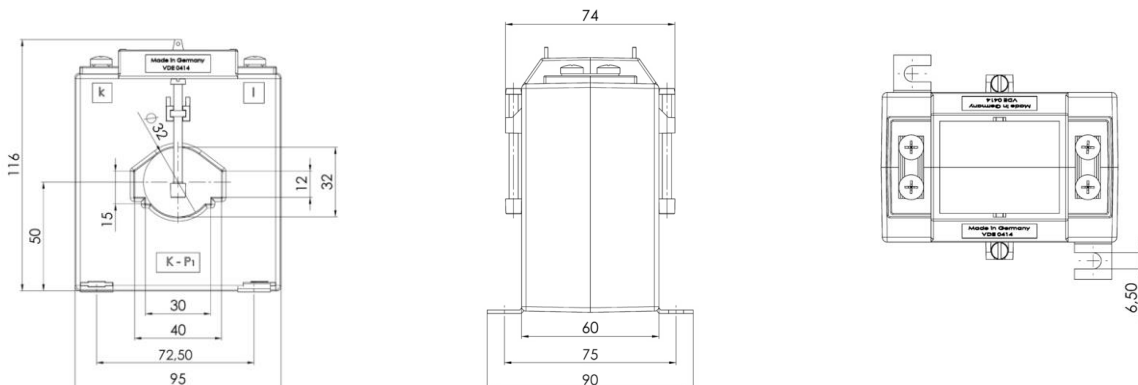

Technical details:

Therm. nominal continuous current I_{cth} : $1,0 \times I_N$
Therm. nominal short-time current I_{th} : $60 \times I_N$, 1 sec.
Max. operating voltage U_m : 0.72 kV
Isolation test voltage: 3 kV, U_{eff} , 50 Hz, 1 min.
Nominal rated frequency: 50 Hz
Isolation class: E

Further information:

Over-current limiting factor: See rating plate
Working temperature range: $-5^\circ\text{C} < T < +40^\circ\text{C}$
Storage temperature range: $-25^\circ\text{C} < T < +40^\circ\text{C}$
Unbreakable plastic housing made of black polycarbonate:
Flame resistant, ultrasonically welded
Nickel-plated secondary terminals with plus-minus nickel-plated screws:
M5x10mm
Package quantity: 1 pcs.
Custom tariff number: 85043129

GMW Contact:

www.g-mw.de
info@g-mw.de

Phone: +49/9103 7129-0
Fax: +49/9103 7129-205/207