

CTB 61.35 Plug-in current transformer

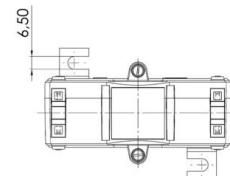

Dimensions:

Bus bar 1: 63 x 10 mm
Bus bar 2: 50 x 30 mm
Round conductor: 43,7 mm
Width: 95 mm
Height: 114,86 mm
Depth: 52 mm

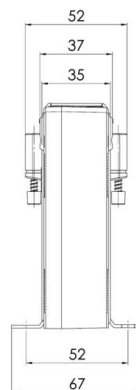
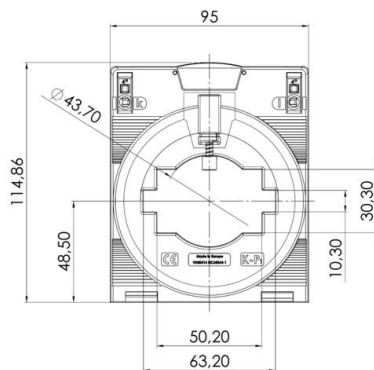

Technical details:

Therm. nominal continuous current I_{cth} : 1,2 x I_N
Therm. nominal short-time current I_{th} : 60 x I_N , 1 sec.
Max. operating voltage U_m : 1.2kV
Isolation test voltage: 6 kV, U_{eff} , 50 Hz, 1 min.
Nominal rated frequency: 50 Hz
Isolation class: E
UL-zertifiziert - Certificate Number - 20100426-E336996

Further information:

Use of spring loaded terminals for connection to the secondary terminals:
Over-current limiting factor: See rating plate
Working temperature range: $-5^{\circ}\text{C} < T < +50^{\circ}\text{C}$
Storage temperature range: $-25^{\circ}\text{C} < T < +50^{\circ}\text{C}$
Package quantity: 1 pcs.
Custom tariff number: 85043129

GMW Contact:

www.g-mw.de
info@g-mw.de

Phone: +49/9103 7129-0
Fax: +49/9103 7129-205/207